

Profilo		Spessore	Sezione Metallica	Massa Leneica	Momento d'inerzia	Raggio d'inerzia	Modulo di elastico	Resistenza plastica	Mon. in torsione	Costante di torsi	Supert. esterna
a mm	b mm	s mm	A cm ²	M kg/m	I cm ⁴	R cm	W cm ³	S cm ³	J cm ⁴	C cm ³	m ² /t
10	10	1.5	0.45	0.35	0.05	0.33	0.10	0.14	0.10	0.16	98.21
12	12	1.5	0.57	0.45	0.10	0.42	0.17	0.22	0.18	0.26	95.42
15	15	1.5	0.75	0.59	0.22	0.54	0.29	0.37	0.38	0.45	92.21
		2	0.94	0.74	0.25	0.51	0.33	0.44	0.46	0.51	72.24
18	18	1.5	0.93	0.73	0.41	0.66	0.45	0.56	0.70	0.69	91.37
		2	1.18	0.92	0.48	0.64	0.53	0.68	0.85	0.82	70.49
20	20	1.5	1.05	0.83	0.58	0.74	0.58	0.72	0.98	0.88	90.63
		2	1.34	1.05	0.69	0.72	0.69	0.88	1.21	1.06	69.68
		2.5	1.59	1.25	0.76	0.69	0.76	1.00	1.39	1.19	57.25
		3	1.81	1.42	0.81	0.67	0.81	1.10	1.52	1.27	49.10
25	25	1.5	1.35	1.06	1.22	0.95	0.97	1.17	2.01	1.47	89.37
		2	1.74	1.36	1.48	0.92	1.19	1.47	2.53	1.80	68.30
		2.5	2.09	1.64	1.69	0.90	1.35	1.71	2.97	2.07	55.74
		3	2.41	1.89	1.84	0.87	1.47	1.91	3.33	2.27	47.45
30	30	1.5	1.65	1.30	2.20	1.15	1.46	1.74	3.57	2.21	88.56
		2	2.14	1.68	2.72	1.13	1.81	2.21	4.54	2.75	67.44
		2.5	2.59	2.03	3.15	1.10	2.10	2.61	5.40	3.20	54.82
		3	3.01	2.36	3.50	1.08	2.33	2.96	6.15	3.58	46.45
		4	3.75	2.94	3.95	1.03	2.64	3.50	7.31	4.11	36.12
35	35	1.5	1.95	1.53	3.59	1.36	2.05	2.43	5.78	3.09	88.00
		2	2.54	1.99	4.51	1.33	2.57	3.09	7.41	3.89	66.85
		2.5	3.09	2.42	5.28	1.31	3.02	3.69	8.89	4.58	54.19
		3	3.61	2.83	5.94	1.28	3.39	4.23	10.22	5.18	45.79
		4	4.55	3.57	6.91	1.23	3.95	5.11	12.42	6.10	35.37
40	40	1.5	2.25	1.77	5.49	1.56	2.74	3.22	8.75	4.13	87.59
		2	2.94	2.31	6.94	1.54	3.47	4.13	11.28	5.23	66.42
		2.5	3.59	2.82	8.21	1.51	4.10	4.97	13.61	6.21	53.74
		3	4.21	3.30	9.31	1.49	4.66	5.72	15.75	7.07	45.32
		4	5.35	4.20	11.06	1.44	5.53	7.01	19.44	8.48	34.84
		5	6.14	4.82	11.35	1.36	5.67	7.59	21.64	9.19	28.74
42	42	1.5	2.37	1.86	6.40	1.64	3.05	3.57	10.17	4.58	87.46
		2	3.10	2.43	8.11	1.62	3.86	4.59	13.14	5.82	66.28
		2.5	3.79	2.97	9.63	1.59	4.59	5.53	15.89	6.93	53.60
		3	4.45	3.49	10.96	1.57	5.22	6.38	18.43	7.92	45.16
		4	5.67	4.45	13.09	1.52	6.23	7.86	22.85	9.54	34.67
		5	6.54	5.14	13.61	1.44	6.48	8.58	25.71	10.45	28.54
45	45	1.5	2.55	2.00	7.95	1.77	3.54	4.13	12.59	5.31	87.28

Profilo		Spessore	Sezione Metallica	Massa Leneica	Momento d'inerzia	Raggio d'inerzia	Modulo di elastico	Resistenza plastica	Mon. in torsione	Costante di torsi	Supert. esterna
a mm	b mm	s mm	A cm ²	M kg/m	I cm ⁴	R cm	W cm ³	S cm ³	J cm ⁴	C cm ³	m ² /t
45	45	2	3.34	2.62	10.12	1.74	4.50	5.32	16.30	6.77	66.09
		2.5	4.09	3.21	12.05	1.72	5.36	6.43	19.77	8.09	53.40
		3	4.81	3.77	13.77	1.69	6.12	7.44	22.99	9.27	44.96
		4	6.15	4.83	16.59	1.64	7.37	9.22	28.67	11.26	34.45
		5	7.14	5.61	17.54	1.57	7.79	10.18	32.70	12.48	28.28
50	50	1.5	2.85	2.24	11.06	1.97	44.3	5.15	17.42	6.65	87.03
		2	3.74	2.93	14.14	1.95	5.66	6.66	22.63	8.51	65.84
		2.5	4.59	3.60	16.94	1.92	6.77	8.07	27.53	10.22	53.14
		3	5.41	4.25	19.46	1.90	7.78	9.39	32.13	11.76	44.68
		4	6.95	5.45	23.71	1.85	9.48	11.73	40.42	14.43	34.15
		5	8.14	6.39	25.62	1.77	10.25	13.16	46.67	16.26	27.94
60	60	1.5	3.45	2.71	19.52	2.38	6.51	7.53	30.48	9.77	86.66
		2	4.54	3.56	25.14	2.35	8.38	9.79	39.79	12.59	65.46
		2.5	5.59	4.39	30.33	2.33	10.11	11.93	48.66	15.22	52.75
		3	6.61	5.19	35.12	2.31	11.71	13.95	57.09	17.65	44.28
		4	8.55	6.71	43.52	2.26	14.51	17.64	72.64	21.97	33.72
		5	10.14	7.96	48.45	2.19	16.15	20.23	86.03	25.32	27.45
		6	11.72	9.20	53.12	2.13	17.71	22.73	97.18	28.10	23.28
65	65	2	4.94	3.88	32.31	2.56	9.94	11.58	50.92	14.93	65.32
		2.5	6.09	4.78	39.10	2.53	12.03	14.14	62.39	18.10	52.60
		4	9.35	7.34	56.61	2.46	17.42	21.05	93.72	26.34	33.56
70	70	2	5.34	4.19	40.72	2.76	11.63	13.52	63.96	17.48	65.19
		2.5	6.59	5.19	49.40	2.74	14.11	16.54	78.49	21.22	52.47
		3	7.81	6.13	57.51	2.71	16.43	19.42	92.42	24.74	44.00
		4	10.15	7.97	72.08	2.67	20.59	24.76	118.52	31.11	33.42
		5	12.14	9.53	81.86	2.60	23.39	28.80	142.12	36.36	27.13
		6	14.12	11.09	91.17	2.54	26.05	32.74	162.58	40.90	22.93
		7	15.96	12.53	98.40	2.48	28.12	36.10	180.04	44.62	19.95
80	80	2	6.14	4.82	61.69	3.17	15.42	17.85	96.34	23.16	65.00
		2.5	7.59	5.96	75.14	3.15	18.78	21.89	118.52	28.22	52.27
		3	9.01	7.07	87.82	3.12	21.96	25.78	139.93	33.02	43.80
		4	11.75	9.22	111.00	3.07	27.75	33.07	180.44	41.84	33.21
		5	14.14	11.10	127.84	3.01	31.96	38.87	218.14	49.39	26.89
		6	16.52	12.97	143.96	2.95	35.99	44.54	251.64	56.08	22.68
		7	18.76	14.72	157.26	2.90	39.32	49.54	281.36	61.81	19.69
		8	20.84	16.36	167.87	2.84	41.97	53.89	307.14	66.61	17.46
90	90	2	6.94	5.45	88.85	3.58	19.74	22.78	138.13	29.64	64.85
		2.5	8.59	6.74	108.54	3.55	24.12	28.00	170.26	36.23	52.12
		3	10.21	8.01	127.26	3.53	28.28	33.04	201.42	42.51	43.64
		4	13.35	10.48	161.87	3.48	35.97	42.58	260.80	54.17	33.05
		5	16.14	12.67	188.39	3.42	41.86	50.44	317.10	64.41	26.72
		6	18.92	14.86	213.90	3.36	47.53	58.14	367.96	73.65	22.50
		7	21.56	16.92	235.72	3.31	52.38	65.08	414.19	81.78	19.50
100	100	2	7.74	6.07	123.00	3.99	24.60	28.30	190.54	36.92	64.73
		2.5	9.59	7.53	150.62	3.96	30.12	34.86	235.21	45.23	52.00
		3	11.41	8.96	177.02	3.94	35.40	41.21	278.68	53.19	43.52
		4	14.95	11.73	226.30	3.89	45.26	53.30	362.01	68.10	32.92

Profilo		Spessore	Sezione Metallica	Massa Leneica	Momento d'inerzia	Raggio d'inerzia	Modulo di elastico	Resistenza plastico	Mon. in torsione	Costante di torsi	Supert. esterna
a mm	b mm	s mm	A cm ²	M kg/m	I cm ⁴	R cm	W cm ³	S cm ³	J cm ⁴	C cm ³	m ² /t
100	100	5	18.14	14.24	265.51	3.83	53.10	63.51	441.98	81.43	26.58
		6	21.32	16.74	303.38	3.77	60.68	73.54	515.15	93.61	22.36
		7	24.36	19.12	336.57	3.72	67.31	82.72	582.73	104.53	19.35
		8	27.24	21.39	365.26	3.66	73.05	91.05	644.51	114.23	17.10
		9	29.28	22.99	270.96	3.56	74.19	94.93	689.09	120.41	15.38
		10	31.71	24.89	386.76	3.49	77.35	100.75	732.24	126.89	14.00
110	110	3	12.61	9.90	138.31	4.35	43.33	50.27	373.51	65.07	43.42
		4	16.55	12.99	305.87	4.30	55.61	65.21	468.47	83.63	32.81
		5	20.14	15.81	361.20	4.23	65.67	78.08	595.80	100.45	26.47
		6	23.72	18.62	414.80	4.18	75.42	90.74	696.79	115.97	22.34
		7	27.16	21.32	462.62	4.13	84.11	102.46	791.17	130.08	19.23
		8	30.44	23.90	504.87	4.07	91.80	113.23	878.70	142.82	16.98
		9	32.88	25.81	519.20	3.97	94.40	119.11	948.69	151.89	15.25
		10	35.71	28.03	545.51	3.91	99.18	127.10	1015.13	161.12	13.86
120	120	3	13.81	10.84	312.32	4.76	52.05	60.24	487.72	78.15	43.33
		4	18.15	14.25	402.21	4.71	67.03	78.03	636.57	100.75	32.73
		5	22.14	17.38	477.46	4.64	79.58	94.15	781.54	121.47	26.38
		6	26.12	20.51	550.56	4.59	91.76	109.75	916.50	140.72	22.15
		7	29.96	23.52	616.68	4.54	102.78	124.29	1043.72	158.41	19.13
		8	33.64	26.41	676.02	4.48	112.67	137.81	1162.95	174.58	16.88
		9	36.48	28.64	702.05	4.39	117.01	145.99	1264.59	186.95	15.14
		10	39.71	31.17	742.11	4.32	123.68	156.46	1360.21	199.32	13.75
140	140	3	16.21	12.72	503.31	5.57	71.90	82.86	781.47	107.92	43.20
		4	21.35	16.76	651.53	5.52	93.08	108.15	1023.32	139.80	32.60
		5	26.14	20.52	779.70	5.46	111.39	130.79	1260.82	169.49	26.24
		6	30.92	24.28	904.71	5.41	129.24	153.15	1484.48	197.41	22.01
		7	35.56	27.91	1019.98	5.36	145.71	174.27	1697.92	223.46	18.99
		8	40.04	31.43	1125.75	5.30	160.82	194.17	1900.84	247.69	16.72
		9	43.68	34.29	1186.03	5.21	169.43	207.85	2086.87	267.82	14.98
		10	47.71	37.45	1264.87	5.15	180.70	224.16	2260.93	287.66	13.58
150	150	3	17.41	13.67	622.69	5.98	83.03	95.53	964.61	124.60	43.15
		4	22.95	18.01	807.73	5.93	107.70	124.87	1264.76	161.73	32.54
		5	28.14	22.09	969.67	5.87	129.29	151.36	1560.35	196.50	26.19
		6	33.32	26.16	1127.89	5.82	150.39	177.55	1839.96	229.35	21.95
		7	38.36	30.11	1274.82	5.77	169.98	202.41	2107.98	260.17	18.93
		8	43.24	33.85	1410.72	5.71	188.10	225.96	2364.08	289.03	16.66
		9	47.28	37.12	1494.35	5.62	199.25	242.84	2604.05	313.63	14.92
		10	51.71	40.59	1599.03	5.56	213.20	262.52	2828.54	337.80	13.51
160	160	3	18.61	14.61	759.60	6.39	94.95	109.09	1174.33	142.48	43.11
		4	24.55	19.27	987.08	6.34	123.38	142.78	1541.45	185.25	32.50
		5	30.14	23.66	1188.22	6.28	148.53	173.43	1903.82	225.51	26.14
		6	35.72	28.04	1385.02	6.23	173.13	203.75	2247.90	263.69	21.90
		7	41.16	32.31	1568.87	6.17	196.11	232.65	2578.94	299.68	18.88
		8	46.44	36.46	1740.03	6.12	217.50	260.14	2896.58	333.56	16.61
		9	50.88	39.94	1851.69	6.03	231.46	280.52	3199.12	363.04	14.86
		10	55.71	43.73	1987.05	5.97	248.38	303.87	3482.31	391.92	13.46
175	175	3	20.41	16.02	1000.44	7.00	114.34	131.13	1542.67	171.55	43.05

Profilo		Spessore	Sezione Metallica	Massa Leneica	Momento d'inerzia	Raggio d'inerzia	Modulo di elastico	Resistenza plastico	Mon. in torsione	Costante di torsi	Supert. esterna
a mm	b mm	s mm	A cm ²	M kg/m	I cm ⁴	R cm	W cm ³	S cm ³	J cm ⁴	C cm ³	m ² /t
175	175	4	26.95	21.15	1303.02	6.95	148.92	171.90	2027.81	223.54	32.44
		5	33.14	26.02	1573.98	6.89	179.88	209.35	2507.94	272.77	26.08
		6	39.32	30.87	1639.61	6.84	210.24	246.43	2966.04	319.69	21.84
		7	45.36	35.61	2089.56	6.79	238.81	281.84	3408.75	364.20	18.82
		8	51.24	40.23	2324.15	6.73	265.62	315.91	3835.69	406.35	16.55
		9	56.28	44.18	2487.49	6.65	284.28	342.10	4249.57	443.88	14.79
		10	61.71	48.44	2678.80	6.59	306.15	371.53	4637.64	480.59	13.39
180	180	3	27.75	21.78	1421.64	7.16	157.96	182.21	2210.16	237.10	32.42
		5	34.14	26.80	1719.02	7.10	191.00	222.08	2734.53	289.53	26.06
		6	40.52	31.81	2010.71	7.04	223.41	261.56	3235.55	339.56	21.82
		7	46.76	36.70	2285.76	6.99	253.97	299.43	3720.36	387.10	18.80
		8	52.84	41.48	2544.49	6.94	282.72	335.70	4188.56	432.21	16.53
		9	58.08	45.60	2727.84	6.85	303.09	363.98	4644.52	472.62	14.77
		10	63.71	50.01	2940.64	6.79	326.74	395.58	5072.33	512.14	13.37
200	200	4	30.95	24.29	1968.01	7.97	196.80	226.44	3048.66	295.34	32.36
		5	38.14	29.94	2388.10	7.91	238.81	276.72	3776.96	361.54	26.00
		6	45.32	35.58	2800.96	7.86	280.10	326.56	4476.23	425.02	21.76
		7	52.36	41.10	3193.05	7.81	319.30	374.60	5155.79	485.70	18.73
		8	59.24	46.51	3564.70	7.76	356.47	420.86	5815.18	543.64	16.46
		9	65.28	51.25	3843.27	7.67	384.33	458.24	6466.24	596.59	14.71
		10	71.71	56.29	4157.65	7.61	415.77	499.29	7078.98	648.32	13.30
220	220	4	34.15	26.81	2639.00	8.79	239.91	275.47	4076.14	359.98	32.32
		5	42.14	33.08	3211.47	8.73	291.95	337.36	5055.11	441.55	25.95
		6	50.12	39.35	3774.98	8.68	343.18	398.76	5998.75	520.08	21.71
		7	57.96	45.50	4313.13	8.63	392.10	458.18	6918.82	595.50	18.68
		8	65.64	51.53	4826.29	8.57	438.75	515.62	7814.54	667.86	16.41
		9	72.48	56.90	5226.79	8.49	475.16	563.31	8707.50	734.93	14.65
		10	79.71	62.57	5670.08	8.43	515.56	615.00	9550.23	800.47	13.24
250	250	4	38.95	30.57	3907.15	10.02	312.57	358.01	6013.70	468.95	32.26
		5	48.14	37.79	4770.81	9.95	381.66	439.57	7466.80	576.56	25.89
		6	57.32	45.00	5622.58	9.90	458.11	520.57	8873.96	680.66	21.65
		7	66.36	52.09	6441.24	9.85	515.30	599.30	10251.14	781.18	18.62
		8	75.24	59.07	7227.22	9.80	578.18	675.77	11597.77	878.18	16.35
		9	83.28	65.38	7667.74	9.72	629.42	741.15	12950.48	969.41	14.59
		10	91.71	71.99	8562.62	9.66	685.01	811.06	14233.23	1058.66	13.18
260	260	4	40.55	31.83	4406.04	10.42	338.93	387.92	6774.85	508.47	32.24
		5	50.14	39.36	5385.06	10.36	414.24	476.64	8414.55	625.55	25.88
		6	59.72	46.88	6351.13	10.31	488.55	564.77	10004.48	738.99	21.63
		7	69.16	54.29	7281.27	10.26	560.10	650.54	11562.11	848.88	18.60
		8	78.44	61.58	8175.95	10.21	628.92	733.95	13086.86	954.68	16.33
		9	86.88	68.20	8913.30	10.13	685.64	805.83	14621.37	1054.77	14.57
		10	95.71	75.13	9709.18	10.07	746.86	882.41	16078.53	1152.71	13.16
300	300	5	58.14	45.64	8367.78	12.00	557.85	639.93	13004.86	841.57	25.82
		6	69.32	54.42	9892.74	11.95	659.52	759.58	15483.15	996.30	21.58
		7	80.36	63.08	11369.40	11.89	757.96	876.49	17919.02	1146.64	18.55
		8	91.24	71.63	12798.27	11.84	853.22	990.67	20311.84	1292.67	16.27
		9	101.28	79.51	14017.75	11.76	934.52	1091.56	22731.72	1432.17	14.51

Profilo		Spessore	Sezione Metallica	Massa Leneica	Momento d'inerzia	Raggio d'inerzia	Modulo di elastico	Resistenza plastico	Mon. in torsione	Costante di torsi	Supert. esterna
a mm	b mm	s mm	A cm ²	M kg/m	I cm ⁴	R cm	W cm ³	S cm ³	J cm ⁴	C cm ³	m ² /t
300	300	10	111.71	87.69	15313.94	11.71	1020.93	1197.83	25041.21	1568.89	13.10
325	325	5	63.14	49.57	10699.74	13.02	658.45	754.17	16564.17	992.83	25.79
		6	75.32	59.13	12664.78	12.97	779.37	895.96	19757.66	1176.61	21.55
		7	87.36	68.58	14572.84	12.92	896.79	1034.78	22881.73	1355.61	18.52
		8	99.24	77.91	16424.49	12.86	1010.74	1170.63	25955.67	1529.91	16.25
		9	110.28	86.57	18030.46	12.79	1109.57	1292.08	29069.65	1697.28	14.48
		10	121.71	95.54	19725.73	12.73	1213.89	1419.34	32049.71	1861.49	13.07



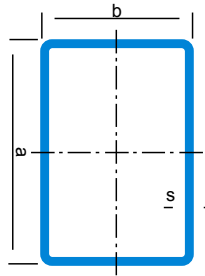

Profilo		Spessore	Sezione	Massa Lineica M	Momento d'inerzia		Raggio d'inerzia		Modulo di resistenza				Mom in Torsione J	Costante di torsi C	Supert. esterna
a mm	b mm	S mm	A cm ²	M kg/m	I _y cm ⁴	I _x cm ⁴	r _y cm	r _x cm	W _x cm ³	W _y cm ³	S _x cm ³	S _y cm ³	J cm ⁴	C cm ³	m ² /t
15	10	1.5	0.60	0.47	0.15	0.08	0.50	0.36	0.20	0.16	0.27	0.20	0.19	0.27	116.06
20	10	1.5	0.75	0.59	0.32	0.11	0.66	0.37	0.32	0.21	0.44	0.26	0.29	0.38	126.79
		2	0.94	0.74	0.37	0.12	0.62	0.35	0.37	0.23	0.52	0.31	0.33	0.42	99.43
20	15	1.5	0.90	0.71	0.45	0.29	0.71	0.56	0.45	0.38	0.58	0.47	0.61	0.63	105.70
		2	1.14	0.89	0.53	0.33	0.68	0.54	0.53	0.44	0.70	0.57	0.74	0.74	81.94
25	10	1.5	0.90	0.71	0.59	0.13	0.81	0.38	0.48	0.56	0.64	0.33	0.39	0.48	133.95
		2	1.14	0.89	0.69	0.15	0.78	0.36	0.55	0.30	0.78	0.39	0.45	0.55	104.35
25	15	1.5	1.05	0.83	0.80	0.36	0.87	0.58	0.64	0.47	0.82	0.57	0.85	0.81	114.85
		2	1.34	1.05	0.95	0.42	0.84	0.56	0.76	0.56	1.01	0.70	1.03	0.96	88.74
		2.5	1.59	1.25	1.05	0.46	0.81	0.54	0.84	0.61	1.15	0.79	1.17	1.07	73.28
		3	1.81	1.42	1.11	0.48	0.78	0.51	0.88	0.63	1.25	0.86	1.27	1.13	63.19
25	20	1.5	1.20	0.94	1.01	0.71	0.92	0.77	0.81	0.71	1.00	0.85	1.40	1.14	100.52
		2	1.54	1.21	1.22	0.85	0.89	0.75	0.97	0.85	1.24	1.06	1.74	1.38	77.19
		2.5	1.84	1.44	1.37	0.96	0.86	0.72	1.10	0.96	1.43	1.22	2.02	1.57	63.32
		3	2.11	1.65	1.47	1.02	0.84	0.70	1.18	1.02	1.58	1.35	2.23	1.70	54.20
30	10	1.5	1.05	0.83	0.98	0.16	0.96	0.39	0.65	0.32	0.89	0.39	0.49	0.59	139.07
		2	1.34	1.05	1.15	0.18	0.93	0.37	0.77	0.36	1.09	0.47	0.58	0.68	107.79
30	15	1.5	1.20	0.94	1.28	0.42	1.03	0.59	0.85	0.57	1.10	0.67	1.09	0.99	121.71
		2	1.54	1.21	1.54	0.50	1.00	0.57	1.03	0.67	1.37	0.83	1.34	1.19	93.77
		2.5	1.84	1.44	1.73	0.56	0.97	0.55	1.15	0.74	1.58	0.95	1.53	1.33	77.18
		2.5	1.84	1.44	1.73	0.56	0.97	0.55	1.15	0.74	1.58	0.95	1.53	1.33	77.18
		3	2.11	1.65	1.85	0.59	0.94	0.53	1.23	0.78	1.74	1.04	1.67	1.42	66.29
30	20	1.5	1.35	1.06	1.59	0.84	1.08	0.79	1.06	0.84	1.32	0.99	1.83	1.40	108.21
		2	1.74	1.36	1.93	1.02	1.06	0.76	1.29	1.02	1.65	1.24	2.29	1.71	82.97
		2.5	2.09	1.64	2.20	1.15	1.03	0.74	1.47	1.15	1.92	1.44	2.68	1.95	67.94
		3	2.41	1.89	2.40	1.24	1.00	0.72	1.60	1.24	2.15	1.61	2.99	2.13	58.03
30	25	1.5	1.50	1.18	1.89	1.42	1.12	0.97	1.26	1.14	1.53	1.35	2.66	1.80	97.40
		2	1.94	1.52	2.33	1.75	1.10	0.95	1.55	1.40	1.93	1.70	3.37	2.23	74.40
		2.5	2.34	1.84	2.68	2.00	1.07	0.93	1.79	1.60	2.27	1.99	3.98	2.57	60.68
		3	2.71	2.13	2.95	2.20	1.04	0.90	1.97	1.76	2.55	2.24	4.50	2.85	51.60
35	10	1.5	1.20	0.94	1.49	0.19	1.11	0.39	0.85	0.37	1.17	0.46	0.60	0.70	142.91
		2	1.54	1.21	1.78	0.21	1.08	0.37	1.02	0.43	1.44	0.55	0.70	0.81	110.34
35	15	1.5	1.35	1.06	1.91	0.49	1.19	0.60	1.09	0.66	1.42	0.77	1.35	1.18	127.05
		2	1.74	1.36	2.32	0.59	1.16	0.58	1.33	0.78	1.77	0.96	1.66	1.42	97.64
		2.5	2.09	1.64	2.64	0.65	1.12	0.56	1.51	0.87	2.07	1.11	1.90	1.59	80.14
		3	2.41	1.89	2.86	0.70	1.09	0.54	1.63	0.93	2.31	1.22	2.08	1.72	68.61
35	20	1.5	1.50	1.18	2.33	0.97	1.25	0.80	1.33	0.97	1.67	1.13	2.28	1.65	114.37

Profilo		Spessore S mm	Sezione A cm ²	Massa Leneica M kg/m	Momento d'inerzia		Raggio d'inerzia		Modulo di resistenza				Mom in Torsione J cm ⁴	Costante di torsi C cm ³	Supert. esterna m ² /t
a mm	b mm				I _v cm ⁴	I _v cm ⁴	r _x cm	r _x cm	W _x cm ³	W _{x3} cm ³	S _x cm ³	S _v cm ³			
35	20	2	1.94	1.52	2.87	1.18	1.22	0.78	1.64	1.18	2.10	1.42	2.87	2.03	87.56
		2.5	2.34	1.84	3.30	1.34	1.19	0.76	1.89	1.34	2.48	1.66	3.36	2.33	71.57
		3	2.71	2.13	3.63	1.46	1.16	0.73	2.07	1.46	2.79	1.86	3.77	2.57	61.01
		4	3.35	2.63	4.01	1.59	1.09	0.69	2.29	1.59	3.25	2.15	4.31	2.85	48.04
35	25	1.5	1.65	1.30	2.75	1.63	1.29	0.99	1.57	1.30	1.92	1.53	3.35	2.13	103.98
		2	2.14	1.68	3.41	2.01	1.26	0.97	1.95	1.61	2.43	1.93	4.25	2.65	79.36
		2.5	2.59	2.03	3.96	2.32	1.24	0.95	2.26	1.86	2.88	2.28	5.05	3.08	64.66
		3	3.01	2.36	4.40	2.57	1.21	0.92	2.51	2.05	3.27	2.57	5.73	3.43	54.92
		4	3.75	2.94	4.98	2.88	1.15	0.88	2.84	2.30	3.87	3.03	6.77	3.93	42.92
35	30	1.5	1.80	1.41	3.17	2.50	1.33	1.18	1.81	1.67	2.18	1.96	4.52	2.61	95.33
		2	2.34	1.83	3.96	3.11	1.30	1.15	2.26	2.08	2.76	2.49	5.78	3.27	72.57
		2.5	2.84	2.23	4.62	3.63	1.28	1.13	2.64	2.42	3.29	2.95	6.90	3.83	58.97
		3	3.31	2.60	5.17	4.05	1.25	1.1	2.95	2.70	3.75	3.36	7.90	4.30	49.94
		4	4.15	3.26	5.94	4.64	1.20	1.06	3.40	3.09	4.49	4.02	9.49	5.01	38.78
40	10	1.5	1.35	1.06	2.15	0.21	1.26	0.40	1.08	0.43	1.49	0.52	0.70	0.81	145.90
		2	1.74	1.36	2.60	0.25	1.22	0.38	1.30	0.49	1.85	0.63	0.83	0.94	112.31
40	15	1.5	1.50	1.18	2.71	0.56	1.34	0.61	1.35	0.75	1.78	0.88	1.60	1.36	131.33
		2	1.94	1.52	3.32	0.67	1.31	0.59	1.66	0.90	2.23	1.09	1.98	1.64	100.71
		2.5	2.34	1.84	3.81	0.75	1.28	0.57	1.90	1.00	2.62	1.26	2.28	1.86	82.46
		3	2.71	2.13	4.17	0.81	1.24	0.55	2.08	1.08	2.95	1.40	2.50	2.01	70.41
40	20	1.5	1.65	1.30	3.26	1.10	1.41	0.81	1.63	1.10	2.07	1.27	2.74	1.91	119.40
		2	2.14	1.68	4.05	1.34	1.38	0.79	2.02	1.34	2.61	1.60	3.45	2.36	91.28
		2.5	2.59	2.03	4.69	1.53	1.35	0.77	2.34	1.53	3.09	1.88	4.06	2.72	74.50
		3	3.01	2.36	5.20	1.68	1.31	0.75	2.60	1.68	3.50	2.12	4.57	3.00	63.39
40	25	1.5	1.80	1.41	3.82	1.84	1.46	1.01	1.91	1.47	2.36	1.70	4.06	2.46	109.46
		2	2.34	1.83	4.77	2.28	1.43	0.99	2.38	1.82	2.99	2.16	5.17	3.07	83.47
		2.5	2.84	2.23	5.57	2.64	1.40	0.96	2.78	2.11	3.56	2.56	6.15	3.59	67.94
		3	3.31	2.60	6.23	2.93	1.37	0.94	3.11	2.35	4.06	2.90	7.00	4.01	57.64
40	27	1.5	1.86	1.46	4.04	2.20	1.47	1.09	2.02	1.63	2.47	1.89	4.63	2.69	105.94
		2	2.42	1.90	5.06	2.73	1.45	1.06	2.53	2.02	3.15	2.39	5.91	3.36	80.71
		2.5	2.94	2.31	5.92	3.18	1.42	1.04	2.96	2.36	3.75	2.85	7.05	3.94	65.63
		3	3.43	2.69	6.64	3.55	1.39	1.02	3.32	2.63	4.28	3.24	8.06	4.42	55.63
40	30	1.5	1.95	1.53	4.38	2.80	1.50	1.20	2.19	1.87	2.64	2.17	5.52	3.02	101.05
		2	2.54	1.99	5.49	3.51	1.47	1.18	2.75	2.34	3.37	2.77	7.07	3.79	76.89
		2.5	3.09	2.42	6.45	4.10	1.44	1.15	3.22	2.73	4.03	3.30	8.47	4.46	62.44
		3	3.61	2.83	7.26	4.60	1.42	1.13	3.63	3.06	4.61	3.77	9.72	5.03	52.85
		4	4.55	3.57	8.45	5.32	1.36	1.08	4.23	3.54	5.57	4.54	11.77	5.91	40.97
40	35	1.5	2.10	1.65	4.93	4.02	1.53	1.38	2.47	2.29	2.93	2.68	7.09	3.57	93.84
		2	2.74	2.15	6.21	5.05	1.51	1.36	3.11	2.89	3.75	3.42	9.12	4.51	71.27
		2.5	3.34	2.62	7.33	5.95	1.48	1.33	3.66	3.40	4.50	4.10	10.97	5.33	57.77
		3	3.91	3.07	8.29	6.71	1.46	1.31	4.14	3.83	5.17	4.71	12.65	6.05	48.79
		4	4.95	3.88	9.75	7.88	1.40	1.26	4.88	4.50	6.29	5.73	15.49	7.19	37.66
45	10	1.5	1.50	1.18	2.98	0.24	1.41	0.40	1.33	0.48	1.85	0.58	0.81	0.92	148.29
		2	1.94	1.52	3.64	0.28	1.37	0.38	1.62	0.56	2.31	0.71	0.96	1.07	113.86
45	15	1.5	1.65	1.30	3.69	0.63	1.50	0.62	1.64	0.84	2.17	0.98	1.86	1.54	134.82
		2	2.14	1.68	4.57	0.76	1.46	0.60	2.03	1.01	2.74	1.22	2.30	1.87	103.21
45	20	1.5	1.80	1.41	4.40	1.23	1.56	0.82	1.96	1.23	2.50	1.41	3.21	2.17	123.60

Profilo		Spessore S mm	Sezione A cm ²	Massa Lineica M kg/m	Momento d'inerzia		Raggio d'inerzia		Modulo di resistenza				Mom in Torsione J cm ⁴	Costante di torsi C cm ³	Supert. esterna m ² /t
a mm	b mm				I _v cm ⁴	I _v cm ⁴	r _x cm	r _y cm	W _x cm ³	W _y cm ³	S _x cm ³	S _y cm ³			
45	20	2	2.34	1.83	5.49	1.50	1.53	0.80	2.44	1.50	3.17	1.78	4.05	2.68	94.37
		2.5	2.84	2.23	6.40	1.73	1.50	0.78	2.85	1.73	3.77	2.10	4.77	3.10	76.91
		3	3.31	2.60	7.14	1.90	1.47	0.76	3.17	1.90	4.29	2.37	5.38	3.44	65.35
45	25	1.5	1.95	1.53	5.11	2.05	1.62	1.02	2.27	1.64	2.83	1.88	4.79	2.80	114.10
		2	2.54	1.99	6.42	2.54	1.59	1.00	2.85	2.03	3.60	2.39	6.11	3.50	86.93
		2.5	3.09	2.42	7.53	2.96	1.56	0.98	3.35	2.37	4.30	2.84	7.28	4.09	70.69
		3	3.61	2.83	8.47	3.30	1.53	0.96	3.76	2.64	4.92	3.23	8.31	4.60	59.91
45	30	1.5	2.10	1.65	5.82	3.11	1.66	1.22	2.59	2.07	3.15	2.39	6.55	3.42	105.96
		2	2.74	2.15	7.34	3.90	1.64	1.19	3.26	2.60	4.03	3.05	8.40	4.31	80.58
		2.5	3.34	2.62	8.66	4.57	1.61	1.17	3.85	3.05	4.83	3.64	10.09	5.09	65.40
		3	3.91	3.07	9.79	5.15	1.58	1.15	4.35	3.43	5.55	4.17	11.60	5.76	55.31
		4	4.95	3.88	11.53	6.00	1.53	1.10	5.12	4.00	6.76	5.06	14.12	6.81	42.81
45	35	1.5	2.25	1.77	6.53	4.44	1.70	1.40	2.90	2.54	3.48	2.93	8.45	4.05	98.90
		2	2.94	2.31	8.27	5.60	1.68	1.38	3.67	3.20	4.46	3.75	10.89	5.13	75.09
		2.5	3.59	2.82	9.79	6.61	1.65	1.36	4.35	3.78	5.36	4.51	13.13	6.09	60.84
		3	4.21	3.30	11.12	7.48	1.63	1.33	4.94	4.28	6.18	5.19	15.18	6.93	51.37
		4	5.35	4.20	13.22	8.84	1.57	1.29	5.87	5.05	7.58	6.35	18.69	8.29	36.90
50	10	1.5	1.65	1.30	4.00	0.27	1.56	0.40	1.60	0.54	2.24	0.65	0.92	1.03	150.25
		2	2.14	1.68	4.92	0.31	1.52	0.38	1.97	0.62	2.82	0.79	1.09	1.20	115.13
50	15	1.5	1.80	1.41	4.89	0.70	1.65	0.62	1.95	0.93	2.60	1.08	2.13	1.72	137.74
		2	2.34	1.83	6.07	0.84	1.61	0.60	2.43	1.12	3.30	1.35	2.63	2.10	105.28
50	20	1.5	1.95	1.53	5.77	1.35	1.72	0.83	2.31	1.35	2.97	1.55	3.69	2.42	127.16
		2	2.54	1.99	7.23	1.67	1.69	0.81	2.89	1.67	3.78	1.96	4.66	3.00	96.98
		2.5	3.09	2.42	8.47	1.92	1.66	0.79	3.39	1.92	4.51	2.32	5.50	3.49	78.49
		3	3.61	2.83	9.50	2.12	1.62	0.77	3.80	2.12	5.16	2.63	6.20	3.88	66.97
50	25	1.5	2.10	1.65	6.65	2.25	1.78	1.04	2.66	1.80	3.33	2.05	5.54	3.13	118.08
		2	2.74	2.15	8.38	2.81	1.75	1.01	3.35	2.25	4.26	2.62	7.06	3.92	89.89
		2.5	3.34	2.62	9.88	3.28	1.72	0.99	3.95	2.62	5.11	3.12	8.43	4.60	73.03
		3	3.91	3.07	11.16	3.66	1.69	0.97	4.46	2.93	5.86	3.56	9.64	5.18	61.83
50	30	1.5	2.25	1.77	7.53	3.41	1.83	1.23	3.01	2.28	3.70	2.60	7.60	3.83	110.22
		2	2.94	2.31	9.53	4.29	1.80	1.21	3.81	2.86	4.74	3.33	9.77	4.84	83.77
		2.5	3.59	2.82	11.29	5.05	1.77	1.19	4.52	3.37	5.70	3.98	11.74	5.72	67.94
		3	4.21	3.30	12.82	5.69	1.75	1.16	5.13	3.80	6.57	4.58	13.53	6.49	57.42
		4	5.35	4.20	15.23	6.68	1.69	1.12	6.09	4.45	8.05	5.58	16.53	7.71	44.37
50	35	1.5	2.40	1.89	8.42	4.86	1.87	1.42	3.37	2.78	4.06	3.18	9.86	4.53	103.33
		2	3.14	2.46	10.69	6.14	1.85	1.40	4.27	3.51	5.22	4.08	12.71	5.75	78.43
		2.5	3.84	3.01	12.70	7.27	1.82	1.38	5.08	4.15	6.29	4.91	15.36	6.84	63.52
		3	4.51	3.54	14.48	8.25	1.79	1.35	5.79	4.27	7.27	5.67	17.78	7.80	53.60
50	40	1.5	2.55	2.00	9.30	6.60	1.91	1.61	3.72	3.30	4.42	3.80	12.26	5.24	97.26
		2	3.34	2.62	11.84	8.38	1.88	1.58	4.74	4.19	5.70	4.89	15.86	6.67	73.73
		2.5	4.09	3.21	14.11	9.97	1.86	1.56	5.65	4.99	6.89	5.90	19.22	7.96	59.63
		3	4.81	3.7	16.14	11.37	1.83	1.54	6.46	5.69	7.98	6.83	22.34	9.12	50.26
		4	6.15	4.83	19.47	13.66	1.78	1.49	7.79	6.83	9.89	8.45	27.82	11.06	38.60
60	10	1.5	1.95	1.53	6.68	0.32	1.85	0.41	2.23	0.65	3.14	0.77	1.13	1.25	153.26
		2	2.54	1.99	8.31	0.38	1.81	0.39	2.77	0.75	3.99	0.95	1.35	1.46	117.06
60	15	1.5	2.10	1.65	7.97	0.84	1.95	0.63	2.66	1.12	3.58	1.28	2.66	2.09	142.32
		2	2.74	2.15	9.99	1.01	1.91	0.61	3.33	1.35	4.57	1.61	3.29	2.55	108.51

Profilo		Spessore S mm	Sezione A cm ²	Massa Lineica M kg/m	Momento d'inerzia		Raggio d'inerzia		Modulo di resistenza				Mom in Torsione J cm ⁴	Costante di torsi C cm ³	Supert. esterna m ² /t
a mm	b mm				I _v cm ⁴	I _v cm ⁴	r _x cm	r _x cm	W _x cm ³	W _x cm ³	S _x cm ³	S _v cm ³			
60	20	1.5	2.25	1.77	9.25	1.61	2.03	0.85	3.08	1.61	4.02	1.83	4.66	2.94	132.84
		2	2.94	2.31	11.68	1.99	1.99	0.82	3.89	1.99	5.15	2.32	5.89	3.65	101.12
		2.5	3.59	2.82	13.79	2.31	1.96	0.80	4.60	2.31	6.18	2.75	6.96	4.26	82.14
		3	4.21	3.30	15.61	2.56	1.93	0.78	5.20	2.56	7.11	3.14	7.87	4.75	69.53
60	25	1.5	2.40	1.89	10.53	2.67	2.09	1.05	3.51	2.13	4.46	2.41	7.05	3.79	124.55
		2	3.14	2.46	13.36	3.34	2.06	1.03	4.45	2.67	5.73	3.08	9.01	4.77	94.67
		2.5	3.84	3.01	15.86	3.91	2.03	1.01	5.29	3.13	6.90	3.68	10.78	5.62	76.79
		3	4.51	3.54	18.05	4.39	2.00	0.99	6.02	3.51	7.97	4.22	12.35	6.35	64.91
60	30	1.5	2.55	2.00	11.82	4.02	2.15	1.26	3.94	2.68	4.90	3.03	9.77	4.64	117.23
		2	3.34	2.62	15.04	5.08	2.12	1.23	5.01	3.38	6.31	3.89	12.57	5.88	89.00
		2.5	4.09	3.21	17.93	6.00	2.09	1.21	5.98	4.00	7.62	4.67	15.14	6.98	72.09
		3	4.81	3.77	20.49	6.79	2.06	1.19	6.83	4.53	8.82	5.39	17.48	7.95	60.86
		4	6.15	4.83	24.67	8.04	2.00	1.14	8.22	5.36	10.92	6.62	21.47	9.52	46.88
60	35	1.5	2.70	2.12	13.10	5.70	2.20	1.45	4.37	3.26	5.34	3.68	12.76	5.50	110.72
		2	3.54	2.78	16.72	7.23	2.17	1.43	5.57	4.13	6.89	4.74	16.49	7.00	83.97
		2.5	4.34	3.41	20.00	8.59	2.15	1.41	6.67	4.91	8.34	5.73	19.95	8.35	67.84
		3	5.11	4.01	22.93	9.79	2.12	1.38	7.64	5.60	9.68	6.63	23.16	9.56	57.28
		4	6.55	5.14	27.81	11.74	2.06	1.34	9.27	6.71	12.04	8.21	28.77	11.58	44.02
60	40	1.5	2.85	2.24	14.39	7.71	2.25	1.64	4.80	3.86	5.77	4.38	15.97	6.35	104.90
		2	3.74	2.93	18.41	9.83	2.22	1.62	6.14	4.91	7.47	5.65	20.70	8.12	79.47
		2.5	4.59	3.60	22.06	11.73	2.19	1.60	7.35	5.87	9.06	6.84	25.14	9.72	64.24
		3	5.41	4.25	25.36	13.43	2.17	1.58	8.45	6.72	10.53	7.94	29.28	11.17	54.10
		4	6.95	5.45	30.95	16.26	2.11	1.53	10.32	8.13	13.16	9.89	36.67	13.65	41.48
		5	8.14	6.39	33.29	17.52	2.02	1.47	11.10	8.76	14.73	11.09	42.22	15.30	34.19
60	45	1.5	3.00	2.36	15.67	10.08	2.28	1.83	5.22	4.48	6.21	5.11	19.37	7.20	99.66
		2	3.94	3.09	20.09	12.89	2.26	1.81	6.70	5.73	8.05	6.61	25.17	9.23	75.43
		2.5	4.84	3.80	24.13	15.44	2.23	1.79	8.04	6.86	9.77	8.02	30.65	11.09	60.92
		3	5.71	4.48	27.80	17.45	2.21	1.76	9.27	7.89	11.39	9.33	35.79	12.79	51.26
		4	7.35	5.77	34.10	21.65	2.15	1.72	11.37	9.62	14.28	11.68	45.08	15.73	39.23
60	50	1.5	3.15	2.47	16.95	12.83	2.32	2.02	5.65	5.13	6.65	5.88	22.94	8.06	94.91
		2	4.14	3.25	21.77	16.45	2.29	1.99	7.26	6.58	8.63	7.62	29.87	10.35	71.79
		2.5	5.09	3.99	26.20	19.76	2.27	1.97	8.73	7.90	10.49	9.26	36.43	12.47	57.93
		3	6.01	4.72	30.24	22.77	2.24	1.95	10.08	9.11	12.24	10.80	42.63	14.41	48.70
		4	7.75	6.08	37.24	27.95	2.19	1.90	12.41	11.18	15.40	13.57	53.92	17.81	37.20
		5	9.14	7.18	40.87	30.70	2.11	1.83	13.62	12.28	17.48	15.41	63.20	20.30	30.45
65	25	1.5	2.55	2.00	12.92	2.87	2.25	1.06	3.97	2.30	5.08	2.58	7.83	4.12	127.21
		2	3.34	2.62	16.42	3.60	2.22	1.04	5.05	2.88	6.54	3.31	10.00	5.19	96.63
		2.5	4.09	3.21	19.55	4.23	2.19	1.02	6.02	3.38	7.89	3.96	11.97	6.12	78.33
		3	4.81	3.77	22.32	4.76	2.15	0.99	6.87	3.81	9.13	4.55	13.72	6.93	66.15
65	35	1.5	2.85	2.24	15.94	6.12	2.36	1.46	4.91	3.50	6.03	3.93	14.24	5.99	113.83
		2	3.74	2.93	20.39	7.78	2.34	1.44	6.28	4.44	7.80	5.07	18.42	7.62	86.29
		2.5	4.59	3.60	24.44	9.25	2.31	1.42	7.52	5.29	9.45	6.13	22.31	9.10	69.79
		3	5.41	4.25	28.09	10.56	2.28	1.40	8.64	6.04	10.99	7.11	25.91	10.44	58.82
		4	6.95	5.45	34.25	12.71	2.22	1.35	10.54	7.26	13.73	8.83	32.24	12.68	45.15
70	20	1.5	2.55	2.00	13.86	1.87	2.33	0.86	3.96	1.87	5.22	2.10	5.64	3.45	137.19
		2	3.34	2.62	17.59	2.32	2.30	0.83	5.03	2.32	6.72	2.68	7.14	4.31	104.27
		2.5	4.09	3.21	20.91	2.69	2.26	0.81	5.97	2.69	8.10	3.19	8.44	5.03	84.56

Profilo		Spessore S mm	Sezione A cm ²	Massa Lineica M kg/m	Momento d'inerzia		Raggio d'inerzia		Modulo di resistenza				Mom in Torsione J cm ⁴	Costante di torsi C cm ³	Supert. esterna m ² /t
a mm	b mm				I _v cm ⁴	I _v cm ⁴	r _x cm	r _x cm	W _x cm ³	W _x cm ³	S _x cm ³	S _v cm ³			
70	20	3	4.81	3.77	23.82	3.00	2.23	0.79	6.81	3.00	9.37	3.65	9.56	5.63	71.45
70	25	1.5	2.70	2.12	15.62	3.08	2.40	1.07	4.46	2.47	5.73	2.76	8.60	4.45	129.58
		2	3.54	2.78	19.91	3.87	2.37	1.05	5.69	3.09	7.40	3.54	11.00	5.61	98.37
		2.5	4.34	3.41	23.76	4.55	2.34	1.02	6.79	3.64	8.94	4.24	13.17	6.63	79.68
		3	5.11	4.01	27.19	5.12	2.31	1.00	7.77	4.10	10.37	4.88	15.11	7.51	67.26
70	30	1.5	2.85	2.24	17.38	4.63	2.47	1.27	4.97	3.09	6.25	3.45	11.99	5.45	122.76
		2	3.74	2.93	22.22	5.86	2.44	1.25	6.35	3.91	8.08	4.45	5.45	6.93	93.11
		2.5	4.59	3.60	26.61	6.94	2.41	1.23	7.60	4.63	9.79	5.36	18.62	8.24	75.34
		3	5.41	4.25	30.55	7.89	2.38	1.21	8.73	5.26	11.38	6.20	21.53	9.41	63.53
		4	6.95	5.45	37.19	9.41	2.31	1.16	10.63	6.27	14.20	7.66	26.53	11.33	28.82
70	35	1.5	3.00	2.36	19.14	6.54	2.52	1.48	5.47	3.74	6.76	4.19	15.75	6.46	116.63
		2	3.94	3.09	24.53	8.32	2.50	1.45	7.01	4.76	8.76	5.40	20.38	8.24	88.38
		2.5	4.84	3.80	29.46	9.92	2.47	1.43	8.42	5.67	10.63	6.54	24.69	9.86	71.45
		3	5.71	4.48	33.93	11.33	2.44	1.41	9.69	6.48	12.38	7.59	28.69	11.32	60.19
		4	7.35	5.77	41.55	13.67	2.38	1.36	11.87	7.81	15.52	9.45	35.76	13.79	46.16
70	40	1.5	3.15	2.47	20.90	8.83	2.57	1.67	5.97	4.41	7.28	4.95	19.82	7.46	111.08
		2	4.14	3.25	26.84	11.27	2.55	1.65	7.67	5.64	9.44	6.41	25.72	9.56	84.10
		2.5	5.09	3.99	32.31	13.49	2.52	1.63	9.23	6.75	11.48	7.78	31.28	11.48	67.94
		3	6.01	4.72	37.30	15.49	2.49	1.61	10.66	7.74	13.39	9.05	36.49	13.23	57.18
		4	7.75	6.08	45.91	18.86	2.43	1.56	13.12	9.43	16.84	11.33	45.84	16.25	43.78
		5	9.14	7.18	50.11	20.60	2.34	1.50	14.32	10.30	19.05	12.84	53.19	18.37	36.03
70	50	1.5	3.45	2.71	24.42	14.59	2.66	2.06	6.98	5.84	8.30	6.61	28.73	9.47	101.43
		2	4.54	3.56	31.47	18.75	2.63	2.03	8.99	7.50	10.80	8.58	37.45	12.20	76.69
		2.5	5.59	4.39	38.00	22.58	2.61	2.01	10.86	9.03	13.16	10.45	45.75	14.72	61.86
		3	6.61	5.19	44.03	26.09	2.58	1.99	12.58	10.44	15.40	12.21	53.62	17.06	51.99
		4	8.55	6.71	54.64	32.20	2.53	1.94	15.61	12.88	19.48	15.41	68.07	21.19	39.68
		5	10.14	7.96	60.69	35.78	2.45	1.88	17.34	14.31	22.30	17.66	80.33	24.35	32.48
		6	11.72	9.20	66.52	39.09	2.38	1.83	19.01	15.64	25.06	19.81	90.44	26.95	27.63
75	40	1.5	3.30	2.59	24.74	9.38	2.74	1.69	6.60	4.69	8.08	5.24	21.78	8.02	113.75
		2	4.34	3.40	31.83	12.00	2.71	1.66	8.49	6.00	10.50	6.79	28.29	10.28	86.10
		2.5	5.34	4.19	38.37	14.37	2.68	1.64	10.23	7.19	12.78	8.25	34.42	12.36	69.53
		3	6.31	4.95	44.37	16.52	2.65	1.62	11.83	8.26	14.93	9.61	40.16	14.26	58.50
		4	8.15	6.40	54.82	20.16	2.59	1.57	14.62	10.08	18.82	12.05	50.52	17.55	44.76
75	50	1.5	3.60	2.83	28.79	15.48	2.83	2.07	7.68	6.19	9.18	6.97	31.70	10.18	104.27
		2	4.74	3.72	37.16	19.91	2.80	2.05	9.91	7.96	11.96	9.06	41.35	13.12	78.83
		2.5	5.84	4.58	44.94	23.99	2.77	2.03	11.98	9.60	14.59	11.04	50.54	15.85	63.58
		3	6.91	5.42	52.15	27.75	2.75	2.00	13.91	11.10	17.09	12.91	59.27	18.38	53.42
		4	8.95	7.02	64.91	34.32	2.69	1.96	17.31	13.73	21.66	16.33	75.33	22.88	40.75
80	15	1.5	2.70	2.12	17.43	1.11	2.54	0.64	4.36	1.48	5.98	1.69	3.73	2.82	148.44
		2	3.54	2.78	22.14	1.35	2.50	0.62	5.53	1.81	7.71	2.13	4.63	3.46	112.78
		2.5	4.34	3.41	26.32	1.54	2.46	0.60	6.58	2.06	9.30	2.51	5.36	3.97	91.43
		3	5.11	4.01	29.99	1.69	2.42	0.57	7.50	2.25	10.76	2.84	5.95	4.36	77.23
80	20	1.5	2.85	2.24	19.74	2.13	2.63	0.86	4.94	2.13	6.57	2.38	6.64	3.97	140.63
		2	3.74	2.93	25.18	2.64	2.60	0.84	6.30	2.64	8.49	3.04	8.40	4.96	106.74
		2.5	4.59	3.60	30.07	3.08	2.56	0.82	7.52	3.08	10.27	3.63	9.94	5.80	86.45
		3	5.41	4.25	34.44	3.43	2.52	0.80	8.61	3.43	11.92	4.16	11.27	6.50	72.95
80	25	1.5	3.00	2.36	22.05	3.50	2.71	1.03	5.51	2.80	7.16	3.11	10.18	5.12	133.60

Profilo		Spessore S mm	Sezione A cm ²	Massa Leneica M kg/m	Momento d'inerzia		Raggio d'inerzia		Modulo di resistenza				Mom in Torsione J cm ⁴	Costante di torzi C cm ³	Supert. esterna m ² /t
a mm	b mm				I _v cm ⁴	I _v cm ⁴	r _x cm	r _x cm	W _x cm ³	W _x cm ³	S _x cm ³	S _v cm ³			
80	25	2	3.94	3.09	28.22	4.40	2.68	1.06	7.06	3.52	9.27	4.00	13.02	6.46	101.32
		2.5	4.84	3.80	33.83	5.18	2.64	1.03	8.46	4.15	11.24	4.81	15.59	7.65	81.98
		3	5.71	4.48	38.88	5.85	2.61	1.01	9.72	4.68	13.07	5.54	17.90	8.68	69.11
80	30	1.5	3.15	2.47	24.36	5.24	2.78	1.29	6.09	3.50	7.75	3.88	14.26	6.27	127.24
		2	4.14	3.25	31.97	6.65	2.75	1.27	7.82	4.43	10.05	5.01	18.37	7.97	96.42
		2.5	5.09	3.99	37.58	7.89	2.72	1.25	9.40	5.26	12.21	6.05	22.17	9.51	77.95
		3	6.01	4.72	43.33	8.99	2.69	1.22	10.83	5.99	14.23	7.01	25.65	10.87	65.66
		4	7.75	6.08	53.19	10.77	2.62	1.18	13.30	7.18	17.87	8.70	31.67	13.15	50.35
80	40	1.5	3.45	2.71	28.99	9.94	2.90	1.70	7.25	4.97	8.93	5.53	23.77	8.57	116.19
		2	4.54	3.56	37.35	12.72	2.87	1.67	9.34	6.36	11.61	7.17	30.88	11.00	87.92
		2.5	5.59	4.39	45.09	15.25	2.84	1.65	11.27	7.63	14.14	8.72	37.58	13.24	70.98
		3	6.61	5.19	52.23	17.55	2.81	1.63	13.06	8.77	16.54	10.16	43.88	15.28	59.70
		4	8.55	6.71	64.75	21.47	2.75	1.58	16.19	10.73	20.91	12.77	55.24	18.44	45.64
		5	10.14	7.96	71.51	23.68	2.66	1.53	17.88	11.84	23.87	14.59	64.42	21.45	37.50
		6	11.72	9.20	78.11	25.65	2.58	1.48	19.53	12.83	26.78	16.29	71.71	23.52	31.97
80	50	2	4.94	3.88	43.44	21.06	2.97	2.07	10.86	8.42	13.17	9.54	45.31	14.04	80.80
		2.5	6.09	4.78	52.60	25.41	2.94	2.04	13.15	10.16	16.08	11.64	55.40	16.98	65.15
		3	7.21	5.66	61.13	29.41	2.91	2.02	15.28	11.76	18.85	13.62	65.00	19.71	54.73
		4	9.35	7.34	76.31	36.44	2.86	1.97	19.08	14.58	23.95	17.25	82.70	24.57	41.74
80	60	2	5.34	4.19	49.52	31.87	3.05	2.44	12.38	10.62	14.73	12.11	61.22	17.08	74.74
		2.5	6.59	5.17	60.12	38.60	3.02	2.42	15.03	12.87	18.02	14.81	75.07	20.73	60.21
		3	7.81	6.13	70.03	44.88	2.99	2.40	17.51	14.96	21.16	17.37	88.35	24.14	50.53
		4	10.15	7.97	87.87	56.08	2.94	2.35	21.97	18.69	26.99	22.12	113.12	30.32	28.45
		5	12.14	9.53	99.67	63.62	2.87	2.29	24.92	21.21	31.37	25.73	135.38	35.38	31.32
		6	14.12	11.09	111.03	70.68	2.80	2.24	27.76	23.56	35.66	29.21	154.58	39.74	26.54
		7	15.96	12.53	119.84	76.12	2.74	2.18	29.96	25.37	39.32	32.18	170.82	43.28	23.15
90	20	1.5	3.15	2.47	27.05	2.38	2.93	0.87	6.01	2.38	8.07	2.66	7.64	4.48	143.41
		2	4.14	3.25	34.64	2.97	2.89	0.85	7.70	2.97	10.46	3.40	9.66	5.61	108.74
		2.5	5.09	3.99	41.53	3.46	2.86	0.82	9.23	3.46	12.69	4.07	11.44	6.57	87.97
		3	6.01	4.72	47.75	3.87	2.82	0.80	10.61	3.87	14.77	4.67	12.98	7.38	74.14
90	30	1.5	3.45	2.71	32.83	5.85	3.09	1.30	7.32	3.90	9.40	4.31	16.55	7.08	130.95
		2	4.54	3.56	42.38	7.43	3.06	1.28	9.42	4.95	12.22	5.57	21.34	9.02	99.15
		2.5	5.59	4.39	51.10	8.84	3.02	1.26	11.36	5.89	14.88	6.73	25.76	10.77	80.10
		3	6.61	5.19	59.11	10.09	2.99	1.24	13.14	6.72	17.38	7.82	29.81	12.34	67.41
		4	8.55	6.71	73.05	12.13	2.92	1.19	16.23	8.09	21.94	9.74	36.86	14.96	51.60
90	40	2	4.94	3.88	50.13	14.16	3.19	1.69	11.14	7.08	13.98	7.93	36.14	12.45	91.12
		2.5	6.09	4.78	60.68	17.01	3.16	1.67	13.48	8.51	17.06	9.65	44.01	15.00	73.52
		3	7.21	5.66	70.47	19.60	3.13	1.65	15.66	9.80	19.99	11.27	51.41	17.34	61.80
		4	8.55	6.71	87.86	24.07	3.07	1.60	19.52	12.03	25.38	14.21	64.82	21.44	47.19
90	50	2	5.34	4.19	57.87	23.36	3.29	2.09	12.86	9.35	15.74	10.50	53.37	15.88	84.29
		2.5	6.59	5.17	70.25	28.23	3.27	2.07	15.61	11.29	19.25	12.82	65.30	19.24	67.94
		3	7.81	6.13	81.33	32.73	3.24	2.05	18.18	13.09	22.60	15.03	76.67	22.36	57.05
		4	10.15	7.97	102.66	40.68	3.18	2.00	22.81	16.27	28.82	19.09	97.70	27.96	43.47
90	60	2	5.74	4.50	65.62	35.23	3.38	2.48	14.58	11.74	17.50	13.27	72.51	19.32	78.41
		2.5	7.09	5.56	79.82	42.74	3.36	2.46	17.74	14.25	21.44	16.24	88.99	23.48	63.15
		3	8.41	6.60	93.19	49.75	3.33	2.43	20.71	16.58	25.21	19.08	108.81	27.39	52.98
		4	10.95	8.59	117.46	62.37	3.28	2.39	26.10	20.79	32.26	24.63	134.44	34.50	40.29

Profilo		Spessore S mm	Sezione A cm ²	Massa Lineica M kg/m	Momento d'inerzia		Raggio d'inerzia		Modulo di resistenza				Mom in Torsione J cm ⁴	Costante di torsi C cm ³	Supert. esterna m ² /t
a mm	b mm				I _v cm ⁴	I _v cm ⁴	r _x cm	r _x cm	W _x cm ³	W _x cm ³	S _x cm ³	S _v cm ³			
100	20	2.5	3.45	2.71	35.94	2.64	3.23	0.87	7.19	2.64	9.72	2.94	8.64	5.00	145.71
		2	4.54	3.56	46.16	3.29	3.19	0.85	9.23	3.29	12.62	3.76	10.94	6.26	110.38
		2.5	5.59	4.39	55.53	3.85	3.15	0.83	11.11	3.85	15.36	4.50	12.96	7.34	89.21
		3	6.61	5.19	64.08	4.31	3.11	0.81	12.82	4.31	17.93	5.18	14.70	8.25	75.12
100	30	2	4.94	3.88	55.76	8.22	3.36	1.29	11.15	5.48	14.58	6.13	24.33	10.07	101.44
		2.5	6.09	4.78	67.42	9.79	3.33	1.27	13.48	6.53	17.80	7.42	29.38	12.03	81.89
		3	7.21	5.66	78.20	11.18	3.29	1.25	15.64	7.46	20.84	8.63	34.02	13.80	68.87
		4	9.35	7.34	97.20	13.49	3.22	1.20	19.44	9.00	26.42	10.78	42.10	16.78	52.64
100	40	2	5.34	4.19	65.37	15.61	3.50	1.71	13.07	7.80	16.54	8.69	41.47	13.89	93.84
		2.5	6.59	5.17	79.30	18.77	3.47	1.69	15.86	9.39	20.23	10.59	50.52	16.76	75.67
		3	7.81	6.13	92.31	21.66	3.44	1.67	18.46	10.38	23.75	12.38	59.05	19.39	63.58
		4	10.15	7.97	115.64	28.67	3.38	1.62	23.13	13.34	30.26	15.65	74.53	24.04	48.49
		5	12.14	9.53	130.01	29.85	3.27	1.57	26.00	14.92	35.01	18.09	87.43	27.60	39.72
		6	14.12	11.09	144.11	32.66	3.19	1.52	28.82	16.33	39.70	20.37	97.94	30.51	33.75
100	50	2	5.74	4.50	74.97	25.67	3.62	2.12	14.99	10.27	18.50	11.46	61.59	17.73	87.29
		2.5	7.09	5.56	91.19	31.05	3.59	2.09	18.24	12.42	22.67	14.01	75.39	21.49	70.34
		3	8.41	6.60	106.43	36.05	3.56	2.07	21.29	14.42	26.66	16.44	88.56	25.01	59.04
		4	10.95	8.59	134.08	44.92	3.50	2.03	26.82	17.97	34.10	20.93	112.99	31.35	44.95
		5	13.14	10.32	152.59	51.03	3.41	1.97	30.52	20.41	39.76	21.41	134.63	36.51	36.69
		6	15.32	12.03	170.66	56.63	3.34	1.92	34.13	22.65	45.34	27.73	153.13	40.92	31.11
		7	17.36	13.63	184.93	60.93	3.23	1.87	36.99	24.37	50.17	30.57	168.54	44.47	27.15
100	60	2	6.14	4.82	84.58	38.60	3.71	2.51	16.92	12.87	20.46	14.43	84.08	21.56	81.60
		2.5	7.59	5.96	103.07	46.88	3.69	2.49	20.61	15.63	25.11	17.68	103.25	26.23	65.70
		3	9.01	7.07	120.55	54.63	3.66	2.46	24.11	18.21	29.57	20.79	121.67	30.64	55.11
		4	11.75	9.22	152.52	68.65	3.60	2.42	30.50	22.88	37.94	2.60	156.27	38.68	41.88
		5	14.14	11.10	175.17	78.79	3.52	2.36	35.03	2.26	44.51	31.23	187.94	45.46	34.10
		6	16.52	12.97	197.20	88.25	3.45	2.31	39.44	29.42	50.98	35.69	215.72	51.40	28.85
		7	18.76	14.72	215.26	95.90	3.39	2.26	43.05	31.97	56.68	39.60	239.89	56.40	25.12
100	70	2	6.54	5.13	94.18	54.60	3.80	2.89	18.84	15.60	22.42	17.60	108.53	25.40	76.61
		2.5	8.09	6.35	114.95	66.49	3.77	2.87	22.99	19.00	27.55	21.60	133.54	30.98	61.64

segue

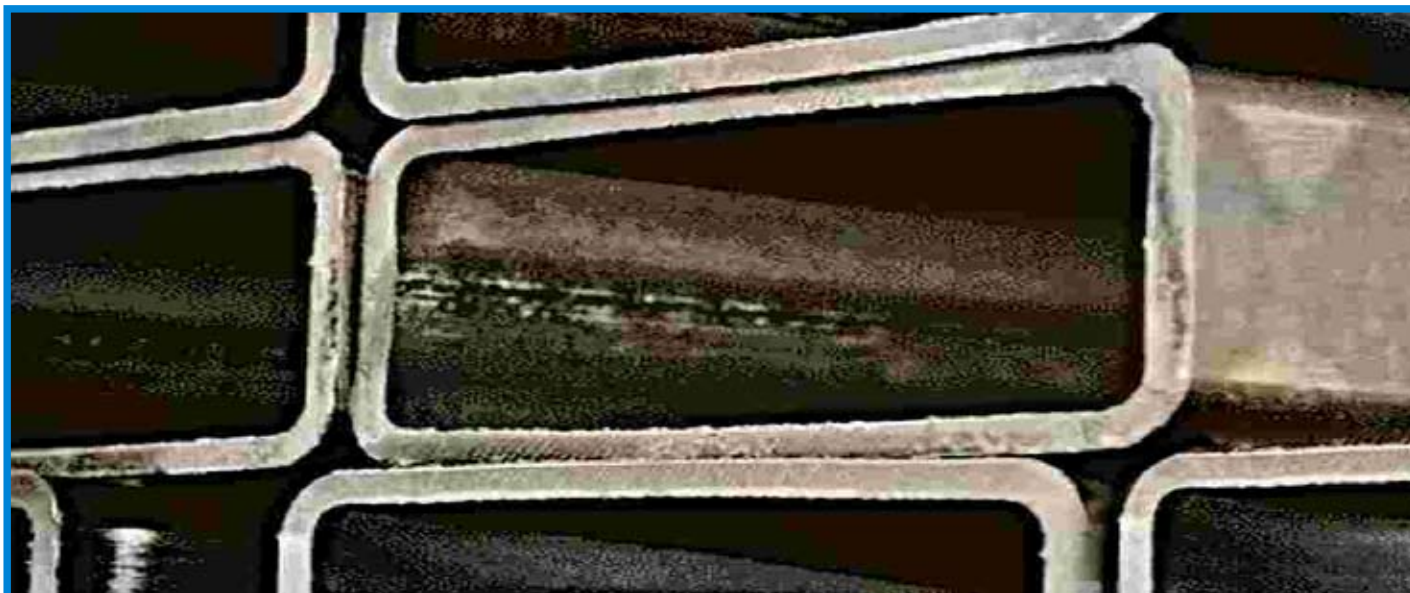

Profilo		Spessore S mm	Sezione A cm ²	Massa Leneica M kg/m	Momento d'inerzia		Raggio d'inerzia		Modulo di resistenza				Mom in Torsione J cm ⁴	Costante di torsi C cm ³	Supert. esterna m ² /t
a mm	b mm				I _v cm ⁴	I _v cm ⁴	r _x cm	r _y cm	W _x cm ³	W _y cm ³	S _x cm ³	S _y cm ³			
100	70	3	9.61	7.54	134.67	77.72	3.74	2.84	26.93	22.21	32.48	25.45	157.70	36.27	51.67
		4	12.55	9.85	170.97	98.25	3.69	2.80	34.19	28.07	41.78	32.68	203.43	46.03	39.21
		5	15.14	11.89	197.76	113.61	3.61	2.74	39.55	32.46	49.26	38.55	246.14	54.44	31.85
		6	17.72	13.91	223.74	128.14	3.55	2.69	44.75	36.61	56.62	44.26	284.22	61.93	26.90
100	80	2	6.94	5.45	103.79	73.86	3.87	3.26	20.76	18.47	24.38	20.97	134.59	29.24	72.19
		2.5	8.59	6.74	126.85	90.16	3.84	3.24	25.37	22.54	29.98	25.77	165.84	35.73	58.05
		3	10.21	8.01	148.79	105.62	3.82	3.22	29.76	26.40	35.39	30.40	196.12	41.91	48.63
		4	13.35	10.48	189.41	134.12	3.77	3.17	37.88	33.53	45.62	39.15	253.79	53.38	36.86
		5	16.14	12.67	220.34	156.01	3.69	3.11	44.07	39.00	54.01	46.37	308.31	63.43	29.87
		6	18.92	14.86	250.29	176.89	3.64	3.06	50.06	44.22	62.26	53.42	357.49	72.48	25.19
		7	21.56	16.92	275.91	194.68	3.58	3.01	55.18	48.67	69.70	59.76	402.06	80.42	21.86
110	50	2	6.14	4.82	94.95	27.98	3.93	2.14	17.26	11.19	21.47	12.42	69.94	19.57	89.91
		2.5	7.59	5.96	115.67	33.87	3.90	2.11	21.03	13.55	26.34	15.20	85.65	23.75	72.42
		3	9.01	7.07	135.24	39.36	3.87	2.09	24.59	15.75	31.01	17.85	100.64	27.66	60.77
		4	1.75	9.22	170.98	49.17	3.81	2.05	31.09	19.67	39.77	22.77	128.51	34.74	46.22
		5	14.14	11.10	195.70	56.12	3.72	1.99	35.58	22.45	46.58	26.66	153.37	40.57	37.70
		6	16.52	12.97	219.89	62.47	3.65	1.94	39.98	24.99	53.30	30.37	174.74	45.58	31.94
		7	18.76	14.72	239.49	67.46	3.57	1.90	43.54	26.98	59.20	33.58	192.76	46.5B	27.84
110	60	2	6.54	5.13	106.61	41.96	4.04	2.53	19.38	13.99	23.66	15.59	95.89	23.80	84.41
		2.5	8.09	6.35	130.12	51.01	4.01	2.51	23.66	17.00	29.03	19.12	117.79	28.99	67.94
		3	9.61	7.54	152.42	59.51	3.98	2.49	27.71	19.84	34.22	22.50	138.87	33.89	56.97
		4	12.55	9.85	193.46	74.93	3.93	2.44	35.17	24.98	44.01	28.84	178.52	42.86	43.28
		5	15.14	11.89	223.28	86.37	3.84	2.39	40.60	28.79	51.83	33.98	215.02	50.51	35.21
		6	17.72	13.91	252.38	97.04	3.77	2.34	45.89	32.35	59.54	38.93	247.22	57.24	29.77
110	100	3	12.01	9.43	221.13	191.14	4.29	3.99	40.21	38.23	47.06	44.12	322.23	58.83	45.58
		4	15.75	12.36	283.39	244.74	4.24	3.94	51.53	48.95	60.97	57.14	419.12	75.47	34.48
		5	19.14	15.03	333.62	288.09	4.17	3.88	60.66	57.62	72.83	68.26	512.50	90.45	27.85
		6	22.52	17.68	382.31	329.92	4.12	3.83	69.51	65.98	84.50	79.18	598.35	104.20	23.43
		7	25.76	20.22	425.44	366.90	4.06	3.77	77.35	73.38	95.25	89.23	678.12	116.61	20.28
120	30	2	5.74	4.50	90.14	9.79	3.96	1.31	15.02	6.53	19.92	7.25	30.38	12.16	105.06
		2.5	7.09	5.56	109.43	11.68	3.93	1.28	18.24	7.79	24.39	8.80	36.69	14.56	84.71
		3	8.41	6.60	127.48	13.38	3.89	1.26	21.25	8.92	28.65	10.25	42.21	16.72	71.16
		4	10.95	8.59	159.90	1622	3.82	1.22	26.65	10.81	36.57	12.86	52.67	20.41	54.25
120	40	2	6.14	4.82	104.06	18.50	4.12	1.74	17.34	9.25	22.28	10.21	52.32	16.78	98.21
		2.5	7.59	5.96	126.69	22.29	4.09	1.71	21.12	11.15	27.32	12.47	63.77	20.27	79.13
		3	9.01	7.07	148.01	25.78	4.05	1.69	24.67	12.89	32.16	14.60	74.56	23.51	66.42
120	40	4	11.75	9.22	186.83	31.88	3.99	1.65	31.14	15.94	41.21	18.53	94.23	29.24	50.56
		5	14.14	11.10	212.79	36.02	3.88	1.60	35.47	18.01	48.15	21.59	110.90	33.76	41.31
		6	16.52	12.97	238.37	39.67	3.80	1.55	36.73	19.83	55.03	24.45	124.69	37.50	35.02
120	60	2	6.94	5.45	131.91	45.33	4.36	2.56	21.99	15.11	27.00	16.75	107.88	26.05	86.88
		2.5	8.59	6.74	161.21	55.15	4.33	2.53	26.87	18.38	33.20	20.56	132.57	31.75	69.92
		3	10.21	8.01	189.09	64.39	4.30	2.51	31.51	21.46	39.18	24.21	153.34	37.14	58.61
		4	13.35	10.48	240.67	81.22	4.25	2.47	40.11	27.07	50.49	31.08	201.12	47.05	44.50
		5	16.14	12.67	278.96	93.95	4.16	2.41	46.49	31.32	59.65	36.73	242.51	55.55	36.19
		6	18.92	14.86	316.41	105.82	4.09	2.36	52.74	35.27	68.71	42.17	279.18	63.09	30.58
		7	21.56	16.92	348.18	115.68	4.02	2.32	58.03	38.56	76.83	47.02	311.57	69.54	26.59
120	80	2	7.74	6.07	159.76	86.03	4.54	3.33	26.63	21.51	31.72	24.09	175.00	35.32	77.90

Profilo		Spessore S mm	Sezione A cm ²	Massa Lineica M kg/m	Momento d'inerzia		Raggio d'inerzia		Modulo di resistenza				Mom in Torsione J cm ⁴	Costante di torsi C cm ³	Supert. esterna m ² /t
a mm	b mm				I _v cm ⁴	I _v cm ⁴	r _x cm	r _x cm	W _x cm ³	W _x cm ³	S _x cm ³	S _v cm ³			
120	80	2.5	9.59	7.53	195.73	105.18	4.52	3.31	32.62	26.29	39.07	29.64	215.82	43.23	62.63
		3	11.41	8.96	230.17	123.42	4.49	3.29	38.36	30.85	46.20	35.02	255.47	50.80	52.45
		4	14.95	11.73	294.52	157.25	4.44	3.24	49.09	39.31	59.77	45.23	331.24	64.93	39.74
		5	18.14	14.24	345.13	184.17	4.36	3.19	57.52	46.04	71.15	53.87	403.45	77.48	32.20
		6	21.32	16.74	394.46	209.82	4.30	3.14	65.74	52.45	82.39	62.30	469.16	88.89	27.14
		7	24.36	19.12	437.68	232.09	4.24	3.09	72.95	58.02	92.65	69.98	529.42	99.06	23.53
		8	27.24	21.39	474.98	251.16	4.18	3.04	79.16	62.79	101.97	76.93	584.04	108.01	20.84
120	100	2.5	10.59	8.31	230.25	174.39	4.66	4.06	39.38	34.88	44.95	39.73	309.43	54.73	56.71
		3	12.61	9.90	271.24	205.26	4.64	4.03	45.21	41.05	53.22	47.03	367.01	64.47	47.46
		4	16.55	12.99	348.36	263.18	4.59	3.99	58.06	52.64	69.05	60.98	477.84	82.83	35.89
		5	20.14	15.81	411.29	310.67	4.52	3.93	68.55	62.13	82.65	73.01	584.99	99.46	29.00
		6	23.72	18.62	472.51	356.46	4.46	3.88	78.75	71.29	96.07	84.82	683.87	114.79	24.39
		7	27.16	21.32	527.18	397.23	4.41	3.82	87.86	79.45	108.47	95.74	776.17	128.70	21.11
130	50	2	6.94	5.45	144.29	32.59	4.56	2.17	22.20	13.03	28.01	14.34	86.94	23.26	94.23
		2.5	8.59	6.74	176.27	39.52	4.53	2.15	27.12	15.81	34.43	17.57	106.51	28.26	75.85
		3	10.21	8.01	206.67	46.00	4.50	2.12	31.80	18.40	40.62	20.67	125.22	32.97	63.61
		4	13.35	10.48	262.79	57.65	4.44	2.08	40.43	23.06	52.32	26.45	160.07	41.52	48.32
		5	16.14	12.67	303.63	66.28	4.34	2.03	46.71	26.51	61.72	31.16	191.43	48.69	39.34
		6	18.92	14.86	343.75	74.16	4.26	1.98	52.88	29.66	71.03	35.65	218.64	54.92	33.27
140	40	2	6.94	5.45	155.03	21.39	4.73	1.76	22.15	10.70	28.82	11.73	63.33	19.67	101.58
		2.5	8.59	6.74	189.26	25.81	4.69	1.73	27.04	12.91	35.41	14.34	77.20	23.79	81.78
		3	10.21	8.01	221.73	28.89	4.66	1.71	31.68	14.95	41.76	16.82	90.30	27.62	68.60
		4	13.35	10.48	281.51	37.08	4.59	1.67	40.22	18.54	53.75	21.41	114.20	34.44	52.13
		5	16.14	12.67	323.86	42.18	4.48	1.62	46.27	21.09	63.29	25.09	134.68	39.92	42.50
		6	18.92	14.86	365.67	46.68	4.40	1.57	52.24	23.34	72.75	28.53	151.77	44.50	35.96
140	60	2	7.74	6.07	193.12	52.06	5.00	2.59	27.59	17.35	34.34	19.07	132.33	30.53	91.07
		2.5	9.59	7.53	236.53	63.42	4.97	2.57	33.79	21.14	42.29	23.43	162.67	37.26	73.25
		3	11.41	8.96	278.05	74.14	4.94	2.55	39.72	24.71	49.98	27.63	191.92	43.64	61.38
		4	14.95	11.73	355.51	93.78	4.88	2.50	50.79	32.26	64.63	35.56	247.13	55.42	46.55
		5	18.14	14.24	415.03	109.12	4.78	2.45	59.29	36.37	76.79	42.23	298.42	65.65	37.82
		6	21.32	16.74	473.48	123.39	4.71	2.41	67.64	41.13	88.83	48.65	344.17	74.78	31.92
		7	24.36	19.12	524.23	135.45	4.64	2.36	74.89	45.15	99.79	54.44	384.95	82.70	27.72
140	70	3	12.01	9.43	306.20	104.68	5.05	2.95	43.74	29.91	54.09	33.49	251.99	51.66	58.31
		4	15.75	12.36	392.52	133.14	4.99	2.91	56.07	38.04	70.07	43.24	326.02	65.94	44.19
		5	19.14	15.03	460.61	155.94	4.91	2.85	65.80	44.56	83.54	51.55	396.03	78.59	35.84
		6	22.52	17.68	527.38	177.44	4.84	2.81	75.34	50.70	96.87	59.62	459.45	90.03	30.22
		7	25.76	20.22	586.20	196.04	4.77	2.76	83.74	56.01	109.10	66.97	517.21	100.18	26.21
140	80	3	12.61	9.90	334.36	141.21	5.15	3.35	47.77	35.30	58.20	39.64	317.07	59.69	55.54
		4	16.55	12.99	429.52	180.38	5.09	3.30	61.36	45.09	75.71	51.31	411.60	76.48	42.05
		5	20.14	15.81	506.20	214.34	5.01	3.25	71.31	53.08	90.29	61.37	502.06	91.54	34.06
		6	23.72	18.62	581.28	242.75	4.95	3.20	83.04	60.69	104.91	71.18	584.89	105.32	28.69
		7	27.16	21.32	648.16	269.51	4.89	3.15	92.59	67.38	118.41	80.20	661.38	117.72	24.86
150	30	2	6.94	5.45	163.71	12.14	4.86	1.32	21.83	8.10	29.43	8.93	39.55	15.30	108.92
		2.5	8.59	6.74	199.66	14.53	4.82	1.30	26.62	9.68	36.14	10.86	47.78	18.35	87.72
		3	10.21	8.01	233.68	16.67	4.78	1.28	31.16	11.12	42.61	12.68	55.37	21.11	73.59
		4	13.35	10.48	296.02	20.31	4.71	1.23	39.47	13.54	54.79	15.98	68.68	25.85	55.95
150	50	2	7.74	6.07	207.52	37.20	5.18	2.19	27.67	14.88	35.35	16.26	104.24	26.94	97.66

Profilo		Spessore S mm	Sezione A cm ²	Massa Leneica M kg/m	Momento d'inerzia		Raggio d'inerzia		Modulo di resistenza				Mom in Torsione J cm ⁴	Costante di torsi C cm ³	Supert. esterna m ² /t
a mm	b mm				I _v cm ⁴	I _v cm ⁴	r _x cm	r _x cm	W _x cm ³	W _x cm ³	S _x cm ³	S _v cm ³			
150	50	2.5	9.59	7.53	254.05	45.17	5.15	2.17	33.87	18.07	43.52	19.95	127.74	32.78	78.57
		3	11.41	8.96	298.51	52.64	5.12	2.15	39.80	21.05	51.43	23.49	150.22	38.28	65.85
		4	14.95	11.73	381.30	66.14	5.05	2.10	50.84	26.45	66.47	30.13	192.14	48.30	49.96
		5	18.14	14.24	443.84	76.45	4.95	2.05	59.18	30.58	78.86	35.66	230.06	56.81	40.62
		6	21.32	16.74	505.45	85.85	4.87	2.01	67.39	34.34	91.15	40.93	263.18	64.25	34.31
		7	24.36	19.12	558.54	93.57	4.79	1.96	74.47	37.43	102.31	45.62	291.81	70.53	29.81
150	100	3	14.41	11.31	460.60	247.61	5.65	4.15	61.41	49.52	73.48	55.76	507.20	81.40	52.14
		4	18.95	14.87	594.52	318.51	5.60	4.10	79.27	63.70	95.67	72.50	661.63	104.94	39.42
		5	23.14	18.17	706.75	378.42	5.53	4.04	94.32	75.68	115.11	87.26	811.70	126.52	31.85
		6	27.32	21.45	816.67	436.10	5.47	4.00	108.89	87.22	134.35	101.74	951.33	146.58	26.77
		7	31.36	24.62	916.68	488.21	5.41	3.95	122.22	97.64	152.36	115.27	1082.81	165.00	23.15
160	40	2	7.74	6.07	219.87	24.28	5.33	1.77	27.48	12.14	36.16	13.25	74.46	22.56	104.24
		2.5	9.59	7.53	269.00	29.33	5.30	1.75	33.63	14.67	44.50	16.22	90.78	27.31	83.88
		3	11.41	8.96	315.86	34.01	5.26	1.73	39.48	17.01	52.57	19.04	106.19	31.74	70.31
		4	14.95	11.73	402.89	42.29	5.19	1.68	50.36	21.14	67.90	24.29	134.35	39.64	53.37
		5	18.14	14.24	467.22	28.35	5.07	1.63	58.40	24.17	80.43	28.59	158.65	46.08	43.43
		6	21.32	16.74	530.82	53.69	4.99	1.59	66.35	26.84	92.87	32.61	179.06	51.50	36.70
160	50	3	12.01	9.43	352.84	55.95	5.42	2.16	44.10	22.38	57.28	24.90	162.83	40.93	66.80
		4	15.75	12.36	451.57	70.38	5.35	2.11	56.45	28.15	74.14	31.97	208.32	51.70	50.66
		5	19.14	15.03	527.30	81.53	5.25	2.06	65.91	32.61	88.18	37.91	249.54	60.88	41.16
		6	22.52	17.68	602.00	91.69	5.17	2.02	75.25	36.68	102.11	43.57	285.63	68.92	34.74
160	80	3	13.81	10.84	463.77	159.01	5.80	3.39	57.97	39.75	71.41	44.26	380.34	68.59	58.09
		4	18.15	14.25	597.62	203.50	5.74	3.35	74.70	50.88	92.86	57.39	494.10	88.03	43.96
		5	22.14	17.38	707.55	240.51	5.65	3.30	88.44	60.13	111.43	68.87	603.21	105.61	35.59
		6	26.12	20.51	815.55	275.67	5.59	3.25	101.94	68.92	129.83	80.06	703.55	121.76	29.95
		7	29.96	23.52	912.96	306.93	5.52	3.20	114.12	76.73	146.97	90.42	796.66	136.39	25.94
		8	33.64	26.41	1000.02	334.44	5.45	3.15	125.00	83.61	162.86	99.97	882.33	149.54	22.93
180	40	3	12.61	9.90	432.81	38.13	5.86	1.74	48.09	19.06	64.58	21.26	122.19	35.85	71.71
		4	16.55	12.99	554.16	47.49	5.79	1.69	61.57	23.75	83.65	27.17	154.63	44.85	54.37
		5	20.14	15.81	646.85	54.52	5.67	1.65	71.87	27.26	99.58	32.09	182.75	52.24	44.18
		6	23.72	18.62	738.61	60.69	5.58	1.60	82.07	30.35	115.40	36.69	206.50	58.50	37.28
180	60	3	13.18	10.84	526.81	93.66	6.18	2.60	58.53	31.22	75.20	34.47	264.88	56.64	65.47
		4	18.15	14.25	678.09	118.91	6.11	2.56	75.34	39.64	97.73	44.52	341.40	72.16	49.58
		5	22.14	17.38	800.02	139.45	6.01	2.51	88.89	46.48	117.08	53.23	412.82	85.86	40.19
		6	26.12	20.51	920.34	158.52	5.94	2.46	102.26	52.84	136.28	61.61	477.06	98.17	33.85
		7	29.26	23.52	1028.06	175.01	5.86	2.42	112.3	58.34	154.11	69.28	534.93	109.03	29.34
180	80	3	15.10	11.78	620.80	176.80	6.43	3.43	68.98	44.20	85.82	48.88	444.87	77.48	60.24
		4	19.75	15.50	802.01	226.63	6.37	3.39	89.11	56.66	111.81	63.47	578.22	99.59	45.56
		5	24.14	18.95	953.18	268.67	6.28	3.34	105.91	67.17	134.58	76.37	706.27	119.68	36.86
		6	28.52	22.39	1102.07	308.60	6.22	3.29	122.45	77.15	157.15	88.94	824.41	138.21	31.01
		7	32.76	25.71	1237.67	344.35	6.15	3.24	137.52	86.09	178.33	100.64	934.39	155.07	26.83
		8	36.84	29.82	1360.27	376.09	6.08	3.19	151.14	94.02	198.10	111.49	1036.02	170.32	23.71
200	100	3	17.41	13.67	924.28	318.20	7.29	4.28	92.43	63.64	113.25	70.31	754.28	109.63	57.79
		4	22.95	18.01	1199.59	410.72	7.23	4.23	119.96	82.14	148.04	91.70	958.38	141.81	43.65
		5	28.14	22.09	1437.27	491.34	7.15	4.18	143.73	98.27	179.22	111.01	1210.53	171.65	35.24
		6	33.32	26.16	1671.52	568.82	7.08	4.13	167.15	113.76	210.16	129.94	1421.61	199.60	29.60
		7	38.36	30.11	1888.76	639.86	7.02	4.08	188.88	127.97	239.50	147.82	1621.76	255.57	25.57

Profilo		Spessore S mm	Sezione A cm ²	Massa Leneica M kg/m	Momento d'inerzia		Raggio d'inerzia		Modulo di resistenza				Mom in Torsione J cm ⁴	Costante di torsi C cm ³	Supert. esterna m ² /t
a mm	b mm				I _y cm ⁴	I _x cm ⁴	r _x cm	r _y cm	W _x cm ³	W _y cm ³	S _x cm ³	S _y cm ³			
200	100	8	43.24	33.95	2089.29	704.68	6.95	4.04	208.93	140.94	267.26	164.65	1810.72	249.60	22.56
		9	47.28	37.12	2200.41	744.82	6.82	3.97	220.04	148.96	286.34	176.83	1930.62	269.43	20.30
		10	51.71	40.59	2350.98	793.43	6.74	3.92	235.10	158.69	309.29	190.75	2139.53	288.87	18.44
200	150	3	20.41	16.02	1215.37	784.78	7.72	6.20	121.54	104.64	142.80	117.58	1478.16	167.81	49.29
		4	26.95	21.15	1583.15	1020.94	7.67	6.16	158.38	136.13	187.24	154.07	1942.03	218.55	37.17
		5	33.14	26.02	1912.69	1232.59	7.60	6.10	191.27	164.35	227.97	187.61	2400.44	266.55	29.93
		6	39.32	30.87	2236.24	1439.11	7.54	6.05	223.62	191.88	268.36	220.75	2837.30	312.23	25.08
		7	45.36	35.61	2540.90	1632.97	7.48	6.00	254.09	217.73	307.05	252.46	3258.90	35.51	21.62
		8	51.24	40.23	2827.00	1814.43	7.43	5.95	282.70	241.92	344.06	282.76	3664.36	396.44	19.03
		9	56.28	44.18	3021.84	1942.28	7.33	5.87	302.18	258.97	372.29	306.29	4056.66	432.77	17.06
		10	61.71	48.44	3254.32	2089.86	7.26	5.82	352.43	278.65	404.29	332.52	4423.93	468.27	15.45
250	100	3	20.41	16.02	1605.57	388.79	8.87	4.36	128.45	77.76	160.52	84.66	1011.74	137.86	61.78
		4	26.95	21.15	2091.51	502.94	8.81	4.32	167.32	100.59	210.41	110.90	1322.52	178.68	46.62
		5	33.14	26.02	2519.56	604.26	8.72	4.27	201.56	120.85	255.82	134.76	1625.31	216.79	37.61
		6	39.32	30.87	2942.92	701.54	8.65	4.22	235.43	140.31	300.97	158.14	1910.39	252.65	31.56
		7	45.36	36.61	3340.31	791.50	8.58	4.18	267.22	158.30	344.15	180.37	2181.58	286.17	27.24
		8	51.24	40.23	3712.10	874.38	8.51	4.13	296.97	174.88	385.37	201.45	2438.66	217.41	24.01
		9	56.28	44.18	3945.45	931.75	8.37	4.07	315.64	186.35	415.80	217.78	2675.29	344.10	21.58
		10	61.71	48.44	4240.12	996.76	8.29	4.02	339.21	199.35	451.06	235.75	2896.51	370.07	19.58
250	150	4	30.95	24.29	2696.72	1234.16	9.33	6.31	215.74	164.55	259.61	183.27	2664.68	275.38	40.60
		5	38.14	29.94	3269.97	1495.50	9.26	6.26	216.60	199.40	317.07	223.86	3296.00	336.62	32.68
		6	45.32	35.58	3836.14	1750.33	9.20	6.21	306.89	233.38	374.17	263.95	3900.18	395.16	27.38
		7	52.36	41.10	4373.95	1991.11	9.14	6.17	349.92	265.48	429.20	302.51	4485.13	450.92	23.60
		8	59.24	46.51	4883.81	2218.13	9.08	6.12	390.70	295.75	482.17	339.56	5050.45	503.96	20.76
		9	65.28	51.25	5252.88	2390.21	8.97	6.05	420.23	318.69	524.25	369.74	5602.77	552.03	18.61
		10	71.71	56.29	5680.95	2580.70	8.90	6.00	454.48	344.09	571.06	402.52	6121.94	598.92	16.85
300	100	4	30.95	24.29	3320.28	595.15	10.36	4.39	221.35	119.03	282.78	130.10	1667.86	215.55	48.83
		5	38.14	29.94	4016.11	717.17	10.26	4.34	267.74	143.43	344.93	158.51	2049.75	261.95	39.36
		6	45.32	35.58	4705.86	834.26	10.19	4.29	313.72	166.85	406.78	186.34	2410.31	305.71	33.00
		7	52.36	41.10	5358.83	943.14	10.12	4.24	357.26	188.63	466.29	212.92	2753.91	346.79	28.47
		8	59.24	46.51	5975.44	1044.09	10.04	4.20	398.36	208.82	523.47	238.25	3080.34	385.24	25.07
		10	71.71	56.29	6900.61	1200.09	9.81	4.09	460.04	240.02	617.38	280.75	3669.20	451.32	20.40
300	150	4	34.95	27.43	4196.49	1447.37	10.96	6.44	279.77	192.98	341.98	212.47	3417.14	332.23	43.24
		5	43.14	33.87	5104.03	1758.42	10.88	6.38	340.27	234.46	418.68	260.11	4227.74	406.70	34.80
		6	51.32	40.29	6002.58	2061.55	10.81	6.34	400.17	274.87	494.98	307.15	5005.62	478.11	29.15
		7	59.36	46.60	6861.47	2349.25	10.75	6.29	457.34	313.23	568.84	352.56	5760.02	546.36	25.11
		8	67.24	52.79	7681.15	2621.84	10.69	6.24	512.08	349.58	640.27	296.36	6490.59	611.52	22.08
		10	81.71	64.14	9003.94	3071.53	10.50	6.13	600.26	409.54	762.83	472.52	7884.90	729.64	17.91
300	200	4	38.95	30.57	5072.70	2736.44	11.41	8.38	338.18	273.64	401.18	304.84	5527.02	448.93	38.90
		5	48.14	37.79	6191.95	3338.94	11.34	8.33	412.80	333.89	492.43	374.22	6857.25	551.61	31.19
		6	57.32	45.00	7299.30	3930.40	11.28	8.28	486.62	393.04	583.18	442.96	8143.43	650.75	26.09
		7	66.36	52.09	8364.11	4497.33	11.23	8.23	557.61	449.73	671.39	509.70	9400.02	746.32	22.46
		8	75.24	59.07	9386.86	5040.12	11.17	8.18	625.79	504.01	757.07	574.46	10626.50	838.38	19.74
		10	91.71	71.99	11107.27	5964.32	11.01	8.06	740.48	596.43	907.83	689.29	13016.03	1009.04	15.95
400	200	5	58.14	45.64	12402.87	4289.77	14.61	8.59	620.14	428.98	758.13	471.72	10186.26	741.73	34.59
		6	69.32	54.42	14663.84	5059.84	14.54	8.54	733.19	505.98	899.80	559.36	12105.10	876.56	28.93
		7	80.36	63.08	16853.06	5801.62	14.48	8.50	842.65	580.16	1038.18	644.80	13983.25	1007.06	24.89

Profilo		Spessore S mm	Sezione A cm ²	Massa Lineica M kg/m	Momento d'inerzia		Raggio d'inerzia		Modulo di resistenza				Mom in Torsione J cm ⁴	Costante di torsi C cm ³	Supert. esterna m ² /t
a mm	b mm				I _v cm ⁴	I _v cm ⁴	r _x cm	r _y cm	W _x cm ³	W _y cm ³	S _x cm ³	S _y cm ³			
400	200	8	91.24	71.63	18971.13	6515.53	14.42	8.45	948.56	651.55	1173.29	728.06	15820.22	1133.29	21.86
		10	111.71	87.69	22642.29	7770.98	14.24	8.34	1132.11	777.10	1416.37	879.29	19414.86	1370.07	17.66
400	250	5	63.14	49.57	14353.28	7022.06	15.08	10.55	717.66	561.76	856.88	623.32	14811.34	936.65	31.85
		6	75.32	59.13	16992.56	8302.24	15.02	10.50	849.63	644.18	1018.00	740.17	17632.22	1109.23	26.62
		7	87.36	68.58	19556.20	9542.17	14.96	10.45	977.81	763.37	1175.73	854.45	20404.48	1277.05	22.89
		8	99.24	77.91	22044.84	10742.34	14.90	10.40	1102.24	859.39	1330.09	966.17	23127.49	1440.19	20.10
		10	121.71	95.54	26445.63	12885.12	14.74	10.29	1322.28	1030.81	1611.37	1171.06	28504.82	1749.52	16.21

segue

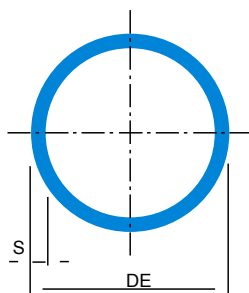

Diametro esterno D mm	Spessore s mm	Sezione Metallica A cm ²	Massa Leneica M kg/m	Momento d'inerzia I cm ⁴	Raggio d'inerzia R cm	Modulo di elastico W cm ³	Resistenza plastica S cm ³	Mon. in torsione J cm ⁴	Costante di torsi C cm ³	Supert. esterna m ² /t
20	1.5	0.87	0.68	0.38	0.66	0.38	0.51	0.75	0.75	91.81
	2	1.13	0.89	0.46	0.64	0.48	0.65	0.93	0.93	70.77
22	1.5	0.97	0.76	0.51	0.73	0.46	0.63	1.02	0.93	91.14
	2	1.26	0.99	0.63	0.71	0.58	0.80	1.27	1.15	70.06
25	1.5	1.11	0.87	0.77	0.83	0.61	0.83	1.54	1.23	90.35
	2	1.45	1.13	0.96	0.82	0.77	1.06	1.93	1.54	69.23
	2.5	1.77	1.39	1.13	0.80	0.91	1.27	2.26	1.81	56.62
	3	2.07	1.63	1.28	0.79	1.02	1.46	2.56	2.04	48.25
28	1.5	1.25	0.98	1.10	0.94	0.79	1.05	2.20	1.57	89.73
	2	1.63	1.28	1.39	0.92	0.99	1.35	2.78	1.98	68.59
	2.5	2.00	1.57	1.64	0.91	1.17	1.63	3.29	2.35	55.95
	3	2.36	1.85	1.87	0.89	1.33	1.88	3.73	2.67	47.56
30	1.5	1.34	1.05	1.37	1.01	0.91	1.22	2.73	1.82	89.40
	2	1.76	1.38	1.73	0.99	1.16	1.57	3.47	2.31	68.24
	2.5	2.16	1.70	2.06	0.98	1.37	1.98	4.12	2.74	55.59
	3	2.54	2.00	2.35	0.96	1.56	2.20	4.69	3.13	47.18
32	1.5	1.44	1.13	1.68	1.08	1.05	1.40	3.35	2.09	89.10
	2	1.88	1.48	2.13	1.06	1.33	1.80	4.26	2.66	67.94
	2.5	2.32	1.82	2.54	1.05	1.59	2.18	5.08	3.17	55.27
	3	2.73	2.15	2.90	1.03	1.82	2.53	5.81	3.63	46.86
35	1.5	1.58	1.24	2.22	1.19	1.27	1.68	4.44	2.54	88.73
	2	2.07	1.63	2.83	1.17	1.62	2.18	5.67	3.24	67.55
	2.5	2.55	2.00	3.39	1.15	1.94	2.65	6.78	3.87	54.88
	3	3.02	2.37	3.89	1.14	2.23	3.08	7.79	4.45	46.44
38	1.5	1.72	1.35	2.87	1.29	1.51	2.00	5.74	3.02	88.42
	2	2.26	1.78	3.68	1.27	1.93	2.59	7.35	3.87	67.23
	2.5	2.79	2.19	4.41	1.26	2.32	3.16	8.83	4.65	54.54
	3	3.30	2.59	5.09	1.24	2.68	3.68	10.18	5.36	46.10
	4	4.27	3.35	6.26	1.21	3.29	4.65	12.52	6.59	35.59
40	1.5	1.81	1.42	3.37	1.36	1.68	2.22	6.73	3.37	88.23
	2	2.39	1.87	4.32	1.35	2.16	2.89	8.64	4.32	67.05
	2.5	2.95	2.31	5.20	1.33	2.60	3.52	10.40	5.20	54.35
	3	3.49	2.74	6.01	1.31	3.00	4.12	12.01	6.01	45.91
	4	4.52	3.55	7.42	1.28	3.71	5.21	14.84	7.42	35.39
42.4	1.51	1.93	1.51	4.04	1.45	1.90	2.51	8.07	3.81	88.04
	2	2.54	1.99	5.19	1.43	2.45	3.27	10.38	4.90	66.85
	2.5	3.13	2.46	6.26	1.41	2.99	3.99	12.52	5.91	54.15

Diametro esterno D mm	Spessore s mm	Sezione Metallica A cm ²	Massa Leneica M kg/m	Momento d'inerzia I cm ⁴	Raggio d'inerzia R cm	Modulo di elastico W cm ³	Resistenza plastica S cm ³	Mon. in torsione J cm ⁴	Costante di torsi C cm ³	Supert. esterna m ² /t
42,4	3	3.71	2.91	7.25	1.40	3.42	4,67	14.49	6,84	45.70
	4	4.83	3.79	8.99	1.36	4.24	5,92	17.98	8.48	35.16
45	1.5	2.05	1.61	4.85	1.54	2.16	2.84	9.71	4.32	87.85
	2	2.70	2.12	6.26	1.52	2.78	3.70	12.52	5.56	66.66
	2.5	3.34	2.62	7.56	1.51	3.36	4.52	15.13	6.72	53.95
	3	3.96	3.11	8.77	1.49	3.90	5.30	17.55	7.80	45.50
	4	5.15	4.04	10.93	1.46	4.86	6.75	21.86	9.71	34.95
48.3	1.5	2.21	1.73	6.04	1.66	2.50	3.29	12.09	5.01	87.55
	2	2.91	2.28	7.81	1.64	3.23	4.29	15.62	6.47	66.45
	2.5	3.60	2.82	9.46	1.62	3.92	5.25	18.92	7.83	53.74
	3	4.27	3.35	11.00	1.61	4.55	6.17	22.00	9.11	45.27
	4	5.57	4.37	13.77	1.57	5.70	7.87	27.54	11.40	34.27
	5	6.80	5.34	16.15	1.54	6.69	9.42	32.31	13.38	28.42
50	1.5	2.29	1.79	6.73	1.72	2.69	3.53	13.45	5.38	87.55
	2	3.02	2.37	8.70	1.70	3.48	4.61	17.40	6.96	66.35
	2.5	3.73	2.93	10.55	1.68	4.22	5.65	21.10	8.44	53.64
	3	4.43	3.48	12.28	1.67	4.91	6.64	24.56	9.82	45.17
	4	5.78	4.54	15.41	1.63	6.16	8.49	30.81	12.32	34.62
52	1,5	2.38	1.87	7.59	1,79	2.92	3.83	15.19	5.84	87.45
	2	3.14	2.47	9.83	1.77	3.78	5.00	19.67	7.56	66.24
	2.5	3.89	3.05	11.94	1.75	4.59	6.13	23.88	9.18	53.53
	3	4.62	3.63	13.91	1.74	5.35	7.21	27.82	10.70	45.06
	4	6.03	4.74	17.49	1.70	6.73	9.24	34.98	13.46	34.50
55	1.5	2.52	1.98	9.03	1.89	3.28	4.29	18.05	6.57	87.31
	2	3.33	2.61	11.71	1.88	4.26	5.62	23.42	8.52	66.10
	2.5	4.12	3.24	14.24	1.86	5.18	6.90	28.48	10.36	53.38
	3	4.90	3.85	16.62	1.84	6.04	8.12	33.24	12.09	44.91
	4	6.41	5.03	20.96	1.81	7.62	10.43	41.93	15.25	34.34
57	1.5	2.62	2.05	10.08	1.96	3.54	4.62	20.15	7.07	87.22
	2	3.46	2.71	13.08	1.95	4.59	6.05	26.17	9.18	66.01
	2.5	4.28	3.36	15.93	1.93	5.59	7.43	31.85	11.18	53.29
	3	5.09	4.00	18.61	1.91	6.53	8.76	37.22	13.06	44.82
	4	6.66	5.23	23.52	1.88	8.25	11.26	47.04	16.50	34.25
60.3	1.5	2.77	2.18	11.98	2.08	3.97	5.19	23.97	7.95	87.09
	2	3.66	2.88	15.58	2.06	5.17	6.80	31.16	10.34	65.88
	2.5	4.54	3.56	18.99	2.05	6.30	8.36	37.99	12.60	53.16
	3	5.40	4.24	22.22	2.03	7.37	9.86	44.45	14.74	44.69
	4	7.07	5.55	28.17	2.00	9.34	12.70	56.35	18.69	34.11
	5	8.69	6.82	33.48	1.96	11.10	15.33	66.95	22.21	27.78
62	1.5	2.85	2.24	13.05	2.14	4.21	5.49	26.10	8.42	87.03
	2	3.77	2.96	16.98	2.12	5.48	7.20	33.97	10.96	65.82
	2,5	4.67	3.67	20.72	2.11	6.68	8.86	41.43	13.37	53.10
	3	5.56	4.37	24.26	2.09	7.83	10.45	48.52	15.65	44.62
	4	7.29	5.72	30.79	2.06	9.93	13.48	61.59	18.97	34.04
65	1.5	3.99	2.35	15.09	2.25	4.64	6.05	30.18	9.29	86.93
	2	3.96	3.11	19.66	2,23	6.05	7.94	39.32	12.10	65.72
	2.5	4.91	3.85	24.01	2.21	7.39	9.77	48.01	17.77	52.99

Diametro esterno D mm	Spessore s mm	Sezione Metallica A cm ²	Massa Leneica M kg/m	Momento d'inerzia I cm ⁴	Raggio d'inerzia R cm	Modulo di elastico W cm ³	Resistenza plastica S cm ³	Mon. in torsione J cm ⁴	Costante di torsi C cm ³	Supert. esterna m ² /t
65	3	5.84	4.59	28.14	2.19	8.66	11.54	56.29	17.32	44.52
	4	7.57	6.02	35.81	2.16	11.02	14.91	71.61	22.04	33.94
70	1.5	3.23	2.53	18.94	2.42	5.41	7.04	37.88	10.82	86.79
	2	4.27	3.35	24.72	2.41	7.06	9.25	49.43	14.12	65.57
	2.5	5.30	4.16	30.23	2.39	8.64	11.40	60.47	17.28	52.84
	3	6.31	4.96	35.50	2.37	10.14	13.48	71.01	20.29	44.36
	4	8.29	6.51	45.33	2.34	12.95	17.45	90.65	25.90	33.78
	5	10.21	8.01	54.24	2.30	15.50	21.17	108.48	31.00	27.44
76.1	1.5	3.52	2.76	24.46	2.64	6.43	8.35	48.93	12.86	86.63
	2	4.66	3.65	31.98	2.62	8.40	10.98	63.86	16.81	65.41
	2.5	5.78	4.54	39.19	2.60	10.30	13.55	78.37	20.60	52.69
	3	6.89	5.41	46.10	2.59	12.11	16.04	92.19	24.23	44.21
	4	9.06	7.11	59.06	2.55	15.52	20.81	118.11	31.04	33.61
	5	11.17	8.77	70.92	2.52	18.64	25.32	141.84	37.28	27.27
	6	13.21	10.37	81.76	2.49	21.49	29.56	163.52	42.97	23.05
80	1.5	3.70	2.90	28.50	2.78	7.13	9.24	57.01	14.25	86.55
	2	4.90	3.85	37.30	2.76	9.32	12.17	74.59	18.65	65.33
	2.5	6.09	4.78	45.75	2.74	11.44	15.02	91.49	22.87	52.60
	3	7.26	5.70	53.87	2.72	13.47	17.80	107.73	26.83	44.12
	4	9.55	7.50	69.15	2.69	17.29	23.13	138.29	34.57	33.52
83	2	5.09	4.00	41.76	2.86	10.06	13.12	83.53	20.13	65.27
	2.5	6.32	4.96	51.26	2.85	12.35	16.21	102.53	24.71	52.54
	3	7.54	5.92	60.40	2.83	14.56	19.21	120.81	29.11	44.06
	4	9.93	7.79	77.64	2.80	18.71	24.99	155.29	37.42	33.46
88.9	2	5.46	4.29	51.57	3.07	11.60	15.11	103.14	23.20	65.16
	2.5	6.79	5.33	63.37	3.06	14.26	18.67	126.75	28.51	52.43
	3	8.10	6.36	74.76	3.04	16.82	22.15	149.53	33.64	43.95
	4	10.67	8.38	96.34	3.00	21.67	28.85	192.68	43.35	33.35
	5	13.18	10.35	116.37	2.97	26.18	35.24	232.75	52.36	27.00
	6	15.63	12.27	134.94	2.94	30.36	41.31	269.88	60.72	22.77
	7	18.01	14.14	152.11	2.91	34.22	47.07	304.23	68.44	19.75
	8	20.33	15.96	167.87	2.87	37.79	52.53	335.93	75.58	17.50
96	2	5.91	4.64	65.26	3.32	13.60	17.67	130.53	27.19	65.05
	2.5	7.34	5.76	80.31	3.31	16.73	21.66	160.61	33.46	52.32
	3	8.77	6.88	94.86	3.29	19.76	25.96	189.72	39.52	43.83
	4	11.56	9.08	122.55	3.26	25.53	33.88	245.09	51.06	33.23
	5	14.29	11.22	148.41	3.22	30.92	41.45	296.62	61.84	26.88
	6	16.96	13.32	172.53	3.19	35.94	48.67	345.08	71.89	22.65
	7	19.57	15.36	194.99	3.16	40.62	55.56	389.97	81.24	19.63
101.6	2	6.26	4.91	77.63	3.52	15.28	19.84	155.26	30.56	64.97
	2.5	7.78	6.11	95.61	3.50	18.82	24.56	191.22	37.64	52.24
	3	9.29	7.29	113.04	3.49	22.25	29.17	226.07	44.50	43.75
	4	12.26	9.63	146.28	3.45	28.80	38.12	292.57	57.59	33.15
	5	15.17	11.91	177.47	3.42	34.93	46.70	354.94	66.87	26.80
	6	18.02	14.15	206.68	3.39	40.68	54.91	413.35	81.37	22.56
	7	20.80	16.33	233.99	3.35	46.06	62.76	467.99	92.12	19.54

Diametro esterno D mm	Spessore s mm	Sezione Metallica A cm ²	Massa Leneica M kg/m	Momento d'inerzia I cm ⁴	Raggio d'inerzia R cm	Modulo di elastico W cm ³	Resistenza plastica S cm ³	Mon. in torsione J cm ⁴	Costante di torsi C cm ³	Supert. esterna m ² /t
101.6	8	23.52	18.47	259.50	3.32	51.08	70.26	519.00	102.17	17.28
108	2	6.66	5.23	93.58	3.75	17.33	22.47	187.15	34.66	64.90
	2.5	8.29	6.50	115.35	3.73	21.36	27.83	230.69	42.72	52.16
	3	9.90	7.77	136.49	3.71	25.28	33.08	272.98	50.55	43.68
	4	13.07	10.26	176.95	3.68	32.77	43.29	353.91	65.54	33.07
	5	16.18	12.70	215.06	3.65	39.83	53.09	430.12	79.65	26.71
	6	19.23	15.09	250.91	3.61	46.46	62.50	501.81	92.93	22.48
114.3	2	7.06	5.54	111.27	3.97	19.47	25.23	222.53	38.94	64.83
	2.5	8.78	6.89	137.26	3.95	24.02	31.25	274.52	48.03	52.09
	3	10.49	8.23	162.55	3.94	28.44	37.17	325.10	56.88	43.61
	4	13.86	10.88	211.07	3.90	36.93	48.69	422.13	73.86	33.00
	5	17.17	13.48	256.92	3.87	44.96	59.77	513.84	88.91	26.64
	6	20.41	16.03	300.21	3.83	52.53	70.45	600.42	105.06	22.41
	7	23.60	18.52	341.04	3.80	59.67	80.71	682.07	119.35	19.39
	8	26.72	20.97	379.49	3.77	66.40	90.57	758.98	132.81	17.12
	9	29.77	23.37	415.67	3.74	72.73	100.04	831.434	145.47	15.36
	10	32.77	25.72	449.66	3.70	78.68	109.12	899.33	157.36	13.96
127	2	7.85	6.17	153.44	4.42	24.16	31.25	306.87	48.33	64.71
	2.5	9.78	7.68	189.53	4.40	29.85	38.76	379.06	59.70	51.98
	3	11.69	9.17	224.75	4.39	35.39	46.14	449.50	70.79	43.49
	4	15.46	12.13	292.61	4.35	46.08	60.54	585.23	92.16	32.88
	5	19.16	15.04	357.14	4.32	56.24	74.46	714.28	112.48	26.52
	6	22.81	17.90	418.44	4.28	65.90	87.92	836.88	131.79	22.28
	7	26.39	20.72	476.63	4.25	75.06	100.91	953.25	150.12	19.26
	8	29.91	23.48	531.80	4.22	83.75	113.46	1063.60	167.50	16.99
	9	33.36	26.19	584.07	4.18	91.98	125.56	1168.15	183.96	15.23
	10	36.76	28.85	633.55	4.15	99.77	137.22	1267.09	199.54	13.83
133	2.5	10.25	8.05	218.27	4.61	32.82	42.58	436.54	65.64	51.93
	3	12.25	9.62	258.97	4.60	38.94	50.71	517.93	77.88	43.44
	4	16.21	12.73	337.53	4.56	50.76	66.59	675.05	101.51	32.83
	5	20.11	15.78	412.40	4.53	62.02	81.96	824.81	124.03	26.47
	6	23.94	18.79	483.72	4.50	72.74	96.85	967.43	145.48	22.23
139.7	2.5	10.78	8.46	253.63	4.85	36.31	47.06	507.27	72.62	51.88
	3	12.88	10.11	301.09	4.83	43.11	56.07	602.18	86.21	43.39
	4	17.05	13.39	392.86	4.80	56.24	73.68	785.72	112.49	32.79
	5	21.16	16.61	480.54	4.77	68.80	90.76	961.08	137.59	26.42
	6	25.20	19.78	564.26	4.73	80.78	107.33	1128.52	161.56	22.8
	7	29.18	22.91	644.14	4.70	92.22	123.38	1288.27	184.43	19.16
	8	33.10	25.98	720.29	4.66	103.12	138.93	1440.58	206.24	16.69
	9	36.95	29.01	792.84	4.63	113.51	153.99	1585.67	227.01	15.13
	10	40.75	31.99	861.89	4.60	123.39	168.55	1723.79	246.78	13.72
152.4	3	14.8	11.05	393.01	5.28	51.58	66.97	786.03	103.15	43.32
	4	18.65	14.64	513.73	5.25	67.42	88.11	1027.46	134.84	32.71
	5	23.15	18.18	629.54	5.21	82.62	108.68	1259.08	165.23	26.34
	6	27.60	21.66	740.57	5.18	97.19	128.67	1481.13	194.37	22.10
	7	31.98	25.10	846.95	5.15	111.15	148.10	1693.90	222.30	19.07
	8	36.29	28.49	948.82	5.11	124.52	166.98	1897.63	249.03	16.81

Diametro esterno D mm	Spessore s mm	Sezione Metallica A cm ²	Massa Leneica M kg/m	Momento d'inerzia I cm ⁴	Raggio d'inerzia R cm	Modulo di elastico W cm ³	Resistenza plastica S cm ³	Mon. in torsione J cm ⁴	Costante di torsi C cm ³	Supert. esterna m ² /t
152.4	9	40.55	31.83	1046.30	5.08	137.31	185.32	2092.60	274.62	15.04
	10	44.74	35.12	1139.53	5.05	149.54	203.11	2279.06	299.09	13.63
159	3	14.70	11.54	47.42	5.52	56.28	73.02	894.84	112.56	43.28
	4	19.48	15.29	585.33	5.48	73.63	96.12	1170.67	147.25	32.67
	5	24.19	18.99	717.88	5.45	90.30	118.62	1435.75	180.60	26.30
	8	28.64	22.64	845.19	5.41	106.31	140.53	1690.37	212.63	22.06
	7	33.43	26.24	967.41	5.38	121.69	161.84	1934.81	243.37	19.04
	8	37.95	29.79	1084.67	5.35	136.44	182.58	2169.34	272.87	16.77
	9	42.41	33.29	1197.12	5.31	150.58	202.74	2394.24	301.16	15.00
168.3	10	46.81	36.75	1304.88	5.28	164.14	222.34	2607.76	328.27	13.59
	3	15.58	12.23	532.28	5.85	63.25	81.98	1064.57	126.51	43.23
	4	20.65	16.21	697.09	5.81	82.84	108.00	1394.18	165.68	32.62
	5	25.65	20.14	855.85	5.78	101.70	133.38	1711.69	203.41	26.26
	6	30.59	24.02	1008.69	5.74	119.87	158.12	2017.39	239.74	22.02
	7	35.47	27.85	1155.79	5.71	137.35	182.84	2311.58	274.70	18.99
	8	40.29	31.63	1297.27	5.67	154.16	205.74	2594.54	308.32	16.72
177.8	9	45.04	35.36	1433.29	5.64	170.33	228.63	2866.58	340.65	14.95
	10	45.73	39.04	1563.98	5.61	185.86	250.92	3127.97	371.71	13.54
	3	16.47	12.93	629.41	6.18	70.80	91.67	1258.82	141.60	43.19
	4	21.84	17.14	825.09	6.15	92.81	120.85	1650.17	185.62	32.58
	5	27.14	21.31	1013.97	6.11	114.06	149.34	2027.94	228.11	26.21
	6	32.38	25.42	1196.22	6.08	134.56	177.16	2392.43	269.12	21.97
	7	37.56	29.49	1371.99	6.04	154.33	204.32	2743.98	308.66	18.94
193.7	8	42.68	33.50	1541.44	6.01	173.39	230.83	3082.87	346.78	16.67
	9	47.73	37.47	1704.72	5.98	191.76	256.68	3409.44	383.51	14.91
	10	52.72	41.38	1861.98	5.94	209.45	281.90	3723.96	418.89	13.50
	3	17.97	14.11	817.22	6.74	84.38	109.11	1834.45	168.76	43.13
	4	23.64	18.71	1072.79	6.71	110.77	143.97	2145.58	221.54	32.52
	5	29.64	23.27	1320.23	6.67	136.32	178.08	2640.46	272.63	26.15
	6	35.38	27.77	1559.72	6.64	161.05	211.46	3119.45	322.09	21.91
219.1	7	41.06	32.23	1791.43	6.61	184.97	244.11	3582.87	369.94	18.88
	8	46.67	36.64	2015.54	6.57	208.11	276.05	4031.07	416.60	16.61
	9	52.22	40.99	2232.20	6.54	230.48	307.27	4464.40	460.96	14.84
	10	57.51	45.30	2441.59	6.50	252.10	337.79	4883.18	504.20	13.43
	3	20.37	15.99	1189.13	7.64	108.55	140.11	2378.26	217.09	43.05
	4	27.03	21.54	1558.38	7.60	142.27	184.67	2617.17	284.54	34.56
	5	33.63	26.40	1928.04	7.57	176.00	229.24	2856.09	351.99	26.07
244.5	6	40.17	31.53	2281.95	7.54	208.30	272.54	4563.89	416.60	21.83
	7	46.64	36.61	2625.75	7.50	239.68	315.02	5251.49	479.37	18.80
	8	53.08	41.65	2959.63	7.47	270.16	356.68	5919.27	540.33	16.53
	9	59.40	46.63	3283.80	7.43	299.75	397.52	6567.60	599.51	14.76
	10	65.69	51.57	3598.44	7.40	328.47	437.56	7196.88	656.95	13.35
	4	30.22	23.72	2185.67	8.50	178.79	231.38	4371.35	357.57	32.38
	5	37.62	29.53	2698.58	8.47	220.74	286.84	5397.16	441.49	26.01
244.5	6	44.96	35.29	3198.53	8.43	261.64	341.37	6397.07	523.28	21.77
	7	52.23	41.00	3685.75	8.40	301.49	394.96	7371.50	602.99	18.73
	8	59.44	46.66	4160.45	8.37	340.32	447.63	8320.89	680.65	16.46

Diametro esterno D mm	Spessore s mm	Sezione Metallica A cm ²	Massa Leneica M kg/m	Momento d'inerzia I cm ⁴	Raggio d'inerzia R cm	Modulo di elastico W cm ³	Resistenza plastica S cm ³	Mon. in torsione J cm ⁴	Costante di torsi C cm ³	Supert. esterna m ² /t
244.5	9	66.59	52.27	4622.84	8.33	378.15	499.39	9245.68	756.29	14.70
	10	73.67	57.83	5073.15	8.30	414.98	550.24	10146.26	829.96	13.28
273	4	33.80	26.54	3058.25	9.51	224.05	289.47	611.50	448.08	32.32
	5	42.10	33.05	3780.81	9.48	276.98	359.16	7561.63	553.97	25.95
	6	50.33	39.51	4487.08	9.44	328.72	427.81	8974.17	657.45	21.71
	7	58.50	45.29	5177.30	9.41	379.29	495.41	10354.60	758.58	18.68
	8	66.60	52.28	5851.71	9.37	428.70	561.97	11703.43	857.39	16.40
	9	74.64	58.60	6510.56	9.34	476.96	627.51	13021.13	953.93	14.64
	10	82.62	64.86	7154.09	9.31	524.11	692.02	14308.19	1042.22	13.22
323.9	4	40.20	31.56	5143.17	11.31	317.58	409.37	10286.33	635.15	32.25
	5	50.09	39.32	6369.42	11.28	393.30	508.53	12738.85	786.59	25.88
	8	59.92	47.04	7572.47	11.24	467.58	606.43	15144.93	935.16	21.63
	7	69.69	54.71	8752.59	11.21	540.45	703.09	17505.18	1080.90	18.60
	8	79.39	62.32	9910.08	11.17	611.92	798.51	19820.16	1223.84	16.33
	9	89.04	69.89	11045.24	11.14	682.02	892.70	22090.47	1364.03	14.56
	10	98.61	77.41	12158.34	11.10	750.75	985.67	24316.68	1501.49	13.14
339.7	5	52.57	41.27	7363.66	11.83	433.54	560.16	14727.33	867.08	25.86
	6	62.90	49.38	8758.31	11.80	515.65	668.21	17516.61	1031.30	21.61
	7	73.16	57.43	10127.00	11.77	596.27	774.94	20255.29	1192.54	18.58
	8	83.37	65.44	11471.99	11.73	675.42	880.37	22943.98	1350.84	16.31
	9	93.50	73.40	12791.65	11.70	753.11	984.51	25583.30	1506.23	14.54
	10	103.58	81.31	14086.92	11.66	829.37	1087.35	28173.84	1658.75	13.13
355.8	5	55.07	43.23	8463.58	12.40	476.02	614.64	16927.15	952.03	25.84
	6	85.90	51.73	10070.55	12.36	566.40	733.39	20141.11	1132.80	21.60
	7	766.66	60.18	11649.71	12.33	655.21	850.77	23299.42	1310.43	18.56
	8	87.36	68.58	13201.37	12.29	742.48	966.78	26402.75	1484.97	16.29
	9	98.00	76.93	14725.86	12.26	828.23	1081.43	29451.73	1656.45	14.52
	10	108.57	85.23	16223.50	12.22	912.46	1194.73	32447.00	1824.92	13.11
406.4	5	63.05	49.50	12700.75	14.19	625.04	805.65	25401.50	1250.07	25.80
	6	75.47	59.25	15128.33	14.16	744.50	961.99	30256.65	1489.01	21.55
	7	87.83	68.95	17519.29	14.12	862.17	1116.76	35038.50	1724.34	18.52
	8	100.13	78.60	19873.89	14.09	978.05	1269.95	39747.79	1956.09	16.24
	9	112.36	88.20	22192.62	14.05	1092.16	1421.58	44385.25	2184.31	14.47
	10	124.53	97.76	24475.81	14.02	1204.52	1571.66	48951.63	2409.04	13.06
457.0	6	85.05	66.76	21646.87	15.95	496.93	1221.56	43293.75	1893.86	21.51
	7	99.00	77.72	25088.77	15.92	1097.50	1418.87	50177.54	2194.99	18.48
	8	112.90	88.62	28484.38	15.88	1246.04	1614.42	56988.77	2942.07	16.21
	9	126.73	99.48	31834.13	15.85	1392.57	1808.19	63668.27	2785.14	14.44
	10	140.49	110.29	35138.43	15.81	1537.11	2000.21	70276.86	3074.23	13.02
508	6	94.62	74.28	29811.53	17.75	1173.68	1512.10	59623.07	2347.36	21.49
	7	110.18	86.49	34574.50	17.71	1361.20	1757.12	69149.00	2722.40	18.45
	8	125.66	98.65	39279.96	17.68	1546.46	2000.17	76559.92	3092.91	16.18
	9	141.09	110.75	43928.39	17.65	1729.46	2241.25	87856.78	3458.93	14.41
	10	156.45	122.81	48520.25	17.61	1910.25	2480.37	97040.49	3820.49	12.99



Diametro esterno	Spessore												
	0,4	0,5	0,6	0,7	0,8	0,9	1	1,2	1,5	1,8	2	2,5	
D mm	Peso Kg/m												
8			0,109	0,126	0,142	0,157	0,173	0,201					
9			0,124	0,143	0,162	0,18	0,197	0,231					
9,5			0,131	0,152	0,171	0,190	0,209	0,245					
9,8			0,136	0,157	0,177	0,197	0,217	0,254					
10		0,117	0,139	0,161	0,181	0,202	0,222	0,260	0,315				
11		0,129	0,153	0,177	0,201	0,224	0,246	0,290	0,351				
12		0,141	0,168	0,195	0,221	0,246	0,271	0,320	0,388				
12,7		0,151	0,179	0,207	0,235	0,262	0,298	0,341	0,415				
13		0,154	0,183	0,212	0,240	0,268	0,296	0,349	0,425				
14	0,134	0,166	0,198	0,229	0,260	0,290	0,320	0,379	0,462	0,541			
15	0,144	0,178	0,213	0,247	0,280	0,313	0,345	0,408	0,499	0,610	0,641		
16	0,153	0,191	0,228	0,264	0,300	0,335	0,370	0,438	0,536	0,630	0,691		
16,75	0,161	0,200	0,239	0,277	0,314	0,352	0,388	0,460	0,564	0,664	0,727		
17	0,163	0,203	0,242	0,281	0,319	0,357	0,394	0,467	0,573	0,675	0,740		
17,5	0,168	0,209	0,250	0,290	0,329	0,368	0,407	0,482	0,592	0,697	0,764		
18	0,173	0,215	0,257	0,299	0,339	0,379	0,419	0,497	0,610	0,719	0,789		
18,3	0,176	0,219	0,262	0,304	0,345	0,386	0,426	0,506	0,621	0,732	0,804		
19	0,183	0,228	0,272	0,316	0,359	0,401	0,444	0,527	0,647	0,763	0,838		
19,8	0,191	0,238	0,284	0,329	0,375	0,419	0,463	0,550	0,677	0,799	0,878		
20	0,193	0,240	0,287	0,333	0,379	0,424	0,469	0,556	0,684	0,808	0,888		
21	0,203	0,252	0,302	0,350	0,398	0,446	0,493	0,586	0,721	0,852	0,937		
21,25	0,205	0,256	0,305	0,354	0,403	0,451	0,499	0,593	0,731	0,863	0,950		
21,3	0,206	0,257	0,307	0,357	0,406	0,455	0,503	0,598	0,736	0,870	0,957		
21,85		0,263	0,314	0,365	0,415	0,465	0,514	0,611	0,753	0,890	0,979		
22		0,265	0,316	0,367	0,418	0,468	0,518	0,616	0,758	0,897	0,986		
22,6		0,273	0,326	0,378	0,430	0,482	0,533	0,634	0,781	0,923	1,017		
23		0,277	0,331	0,385	0,438	0,490	0,542	0,645	0,795	0,941	1,030		
23,5		0,283	0,339	0,393	0,448	0,501	0,555	0,660	0,814	0,963	1,060	1,290	
24		0,289	0,346	0,402	0,457	0,513	0,567	0,675	0,832	0,986	1,080	1,326	
24,7		0,299	0,357	0,415	0,472	0,529	0,585	0,696	0,859	1,017	1,120	1,370	
25		0,302	0,361	0,419	0,477	0,535	0,592	0,704	0,869	1,030	1,130	1,380	
25,4		0,307	0,367	0,426	0,485	0,544	0,602	0,716	0,884	1,040	1,150	1,410	

Diametro esterno	Spessore									
	0,6	0,7	0,8	0,9	1	1,2	1,5	1,8	2	2,5
D mm	Peso Kg/m									
26	0,376	0,436	0,497	0,557	0,616	0,734	0,906	1,07	1,18	1,44
26,2	0,379	0,440	0,501	0,561	0,621	0,740	0,914	1,08	1,19	1,46
26,75	0,387	0,449	0,512	0,574	0,635	0,756	0,934	1,10	1,22	1,49
27	0,390	0,454	0,517	0,579	0,641	0,763	0,943	1,11	1,23	1,51
28	0,405	0,471	0,536	0,601	0,666	0,793	0,980	1,16	1,28	1,57
28,6	0,415	0,482	0,549	0,615	0,681	0,811	1,003	1,19	1,313	1,61
30	0,435	0,506	0,576	0,646	0,715	0,852	1,050	1,25	1,38	1,70
31	0,454	0,528	0,602	0,675	0,747	0,891	1,100	1,31	1,44	1,77
31,6	0,457	0,532	0,606	0,679	0,752	0,897	1,110	1,32	1,45	1,78
32	0,464	0,540	0,615	0,690	0,764	0,912	1,120	1,34	1,48	1,81
33	0,479	0,557	0,635	0,712	0,789	0,941	1,160	1,38	1,52	1,88
33,4		0,566	0,645	0,723	0,801	0,956	1,180	1,40	1,55	1,91
34		0,575	0,655	0,735	0,814	0,971	1,200	1,43	1,57	1,94
35		0,592	0,675	0,757	0,838	1,000	1,240	1,47	1,63	2,00
36			0,694	0,779	0,863	1,030	1,270	1,51	1,67	2,06
37,4			0,722	0,810	0,898	1,070	1,328	1,58	1,74	2,15
38			0,734	0,823	0,912	1,090	1,350	1,61	1,78	2,19
39,7			0,754	0,846	0,937	1,110	1,380	1,65	1,82	2,25
40			0,773	0,868	0,962	1,150	1,420	1,70	1,87	2,31
41			0,793	0,890	0,987	1,178	1,462	1,741	1,924	2,375
41,5			0,803	0,901	0,999	1,190	1,480	1,76	1,94	2,40
42			0,813	0,912	1,010	1,200	1,490	1,78	1,97	2,43
43			0,832	0,934	1,036	1,237	1,536	1,829	2,023	2,498
44			0,852	0,957	1,061	1,267	1,573	1,874	2,072	2,560
44,6			0,862	0,968	1,073	1,282	1,591	1,896	2,097	2,590
45			0,872	0,979	1,090	1,300	1,610	1,92	2,12	2,62
46			0,892	1,001	1,110	1,326	1,647	1,963	2,171	2,683
47,6			0,924	1,037	1,15	1,374	1,706	2,034	2,25	2,782
48			0,931	1,040	1,150	1,380	1,720	2,05	2,27	2,80
49,3			0,957	1,075	1,192	1,424	1,769	2,109	2,334	2,887
50			0,971	1,090	1,210	1,440	1,790	2,14	2,37	2,93
50,8			0,990	1,110	1,233	1,474	1,832	2,185	2,418	2,991

Diametri		Spessore mm.	Peso kg/m	Pressione di esercizio kg/cm ²
pollici	esterno mm.			
3/8"	17,2	2,35	0,85	200
		2,95	1,02	250
		4,00	1,31	400
1/2"	21,3	2,65	1,22	200
		3,25	1,45	250
		5,00	2,00	400
3/4"	26,9	2,65	1,58	200
		3,25	1,90	250
		4,00	2,28	250
		5,90	3,06	400
1"	33,7	3,25	2,44	200
		4,05	2,97	320
		5,00	3,50	400
		7,10	4,67	400
1 1/4"	42,4	3,25	3,14	160
		4,05	3,84	200
		5,90	5,31	250
		8,80	7,27	400
1 1/2"	48,3	3,25	3,61	160
		4,05	4,43	200
		5,00	5,34	320
		7,1	7,24	400
2"	60,3	3,65	5,10	125
		4,50	6,17	160
		5,60	7,53	250
		8,80	11,1	400
2 1/2"	76,1	3,65	6,51	100
		4,50	7,90	125
		5	8,77	160
		5,9	10,20	200
		8,8	14,6	320
		11	17,7	400
3"	88,9	4,05	8,47	100
		4,85	10,10	125
		5,6	11,50	160
		7,1	14,40	200
		10	19,5	320
		12,5	23,7	400

Diametro esterno mm.	Spessore mm.	Peso kg/mq	Diametro esterno mm.	Spessore mm.	Peso kg/mq
26,9	2,0	1,24	114,3	3,6	9,90
30	2,3	1,59	133	4,0	12,80
33,7	2,3	1,79	139,7	4,0	13,50
38	2,6	2,29	159	4,5	17,10
42,4	2,6	2,57	168,3	4,5	18,10
44,5	2,6	2,70	193,7	5,4	25,00
48,3	2,6	2,95	219,1	5,9	31,00
54	2,6	3,32	244,5	6,3	37,10
57	2,9	3,90	273	6,3	41,60
60,3	2,9	4,14	323,9	7,1	55,60
70	2,9	4,83	355,6	8,0	68,30
76,1	2,9	5,28	368	8,0	70,80
88,9	3,2	6,81	406,4	8,8	85,90
101,6	3,6	8,76	419	8,8	88,70
108	3,6	9,33			

N.B. Per ogni diametro disponibilità di relative curve a saldare e flange.

TUBO "GAS" SENZA SALDATURA

serie normale (nero e zincato)

Diametri			Spessore mm.	v.m. kg/m	liscio kg/m
D.N.	Pollici	Esterno mm.			
6	1/8"	10,2	1,80	0,372	0,369
8	1/4"	13,5	2,00	0,577	0,573
10	3/8"	17,2	2,00	0,753	0,747
15	1/2"	21,3	2,35	1,11	1,10
20	3/4"	26,9	2,35	1,42	1,41
25	1"	33,7	2,90	2,23	2,21
32	1 1/4"	42,4	2,90	2,87	2,84
40	1 1/2"	48,3	2,90	3,30	3,26
50	2"	60,3	3,25	4,63	4,56
70	2 1/2"	76,1	3,25	5,93	5,81
80	3"	88,9	3,65	7,82	7,65
100	4"	114,3	4,05	11,30	11,00
125	5"	139,7	4,85	16,70	16,20
150	6"	165,1	4,85	19,80	19,20

TUBO "GAS" SALDATO (FRETZ-MOON)

serie leggera

Diametri			Spessore mm.	liscio kg/m	v.m. kg/m
D.N.	Pollici	Esterno mm.			
10	3/8"	17,2	1,80	0,674	0,75
15	1/2"	21,3	2,00	0,952	1,04
20	3/4"	26,9	2,35	1,410	1,53
25	1"	33,7	2,65	2,010	2,16
32	1 1/4"	42,4	2,65	2,580	2,78
40	1 1/2"	48,3	2,90	3,250	3,48
50	2"	60,3	2,90	4,110	4,42
70	2 1/2"	76,1	3,25	5,800	6,22
80	3"	88,9	3,25	6,810	7,20
100	● 4"	114,3	3,65	9,890	10,20
125	● 5"	139,7	4,50	14,90	15,40

● Saldato tipo FM

1 A

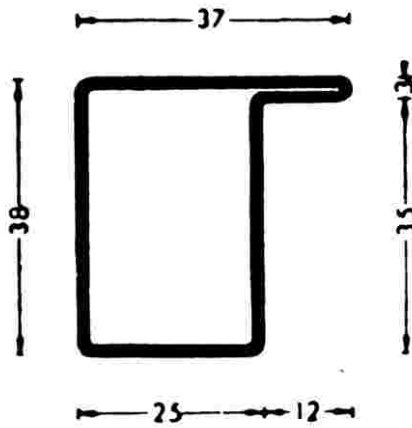

Spessore 15/10 Peso kg/m. 1,72

1 B

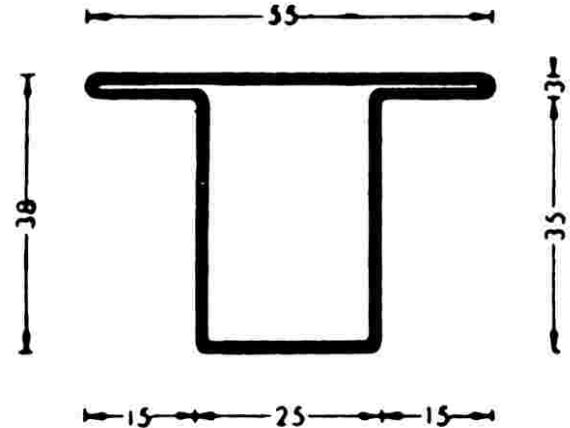

Spessore 15/10 Peso kg/m. 2,10

1 C

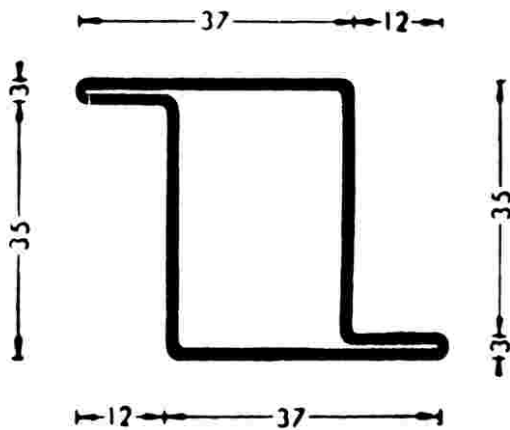

Spessore 15/10 Peso kg/m. 1,99

11 A

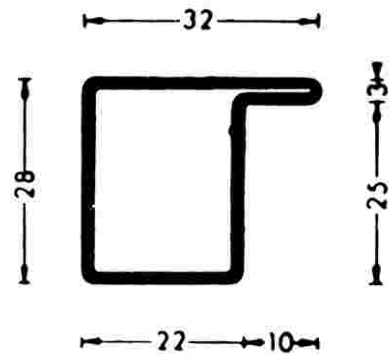

Spessore 15/10 Peso kg/m. 1,34

11 B

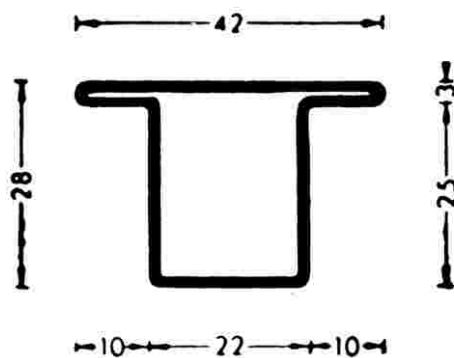

Spessore 15/10 Peso kg/m. 1,57

11 C

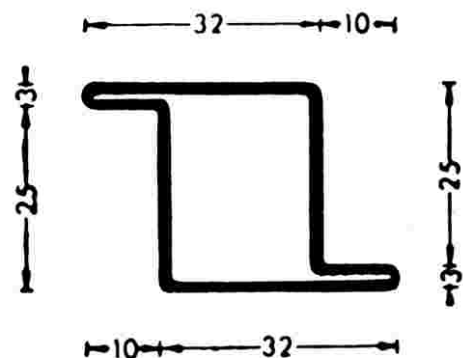

Spessore 15/10 Peso kg/m. 1,57

2 A

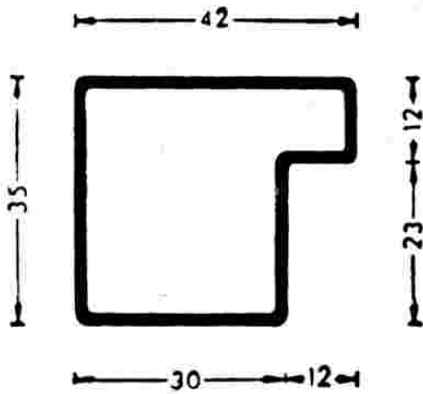

Spessore 15/10 Peso kg/m. 1,72

2 B

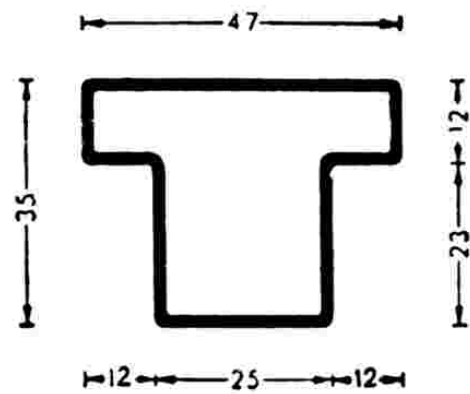

Spessore 15/10 Peso kg/m. 1,81

2 Z

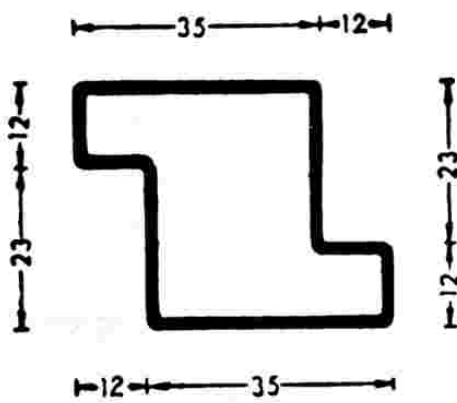

Spessore 15/10 Peso kg/m. 1,81

2 N

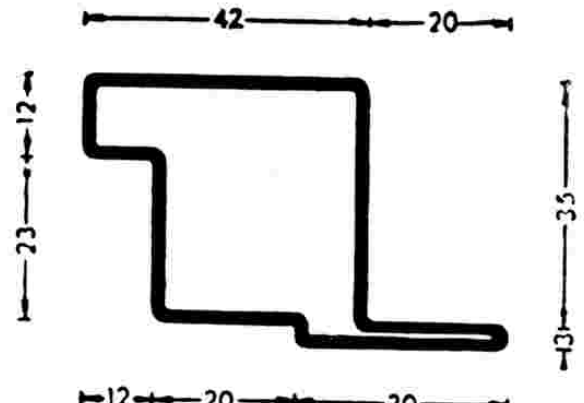

Spessore 15/10 Peso kg/m. 2,15

2 C

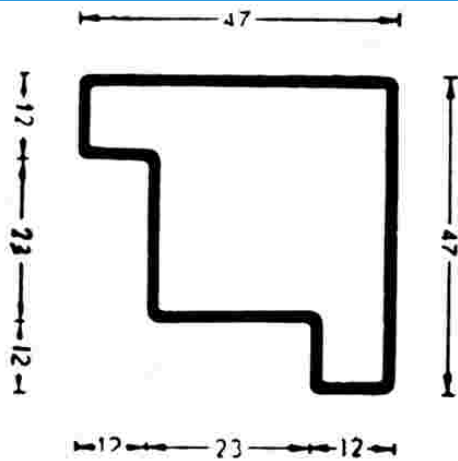

Spessore 15/10 Peso kg/m. 2,15

2 T

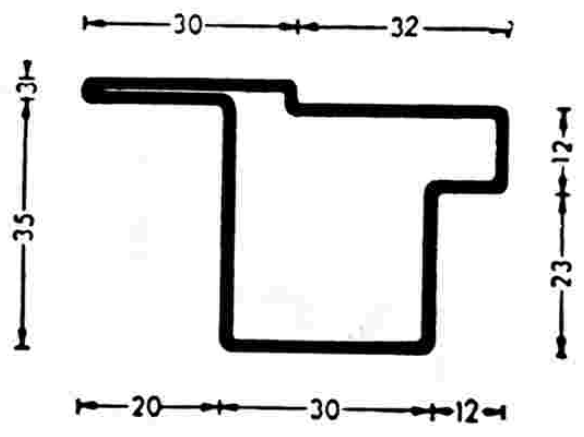

Spessore 15/10 Peso kg/m. 2,16

2 D

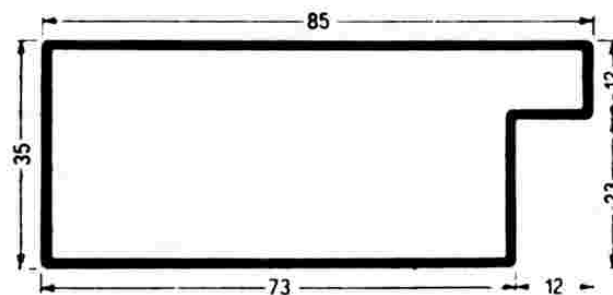

Spessore 15/10

Peso kg/m. 2,78

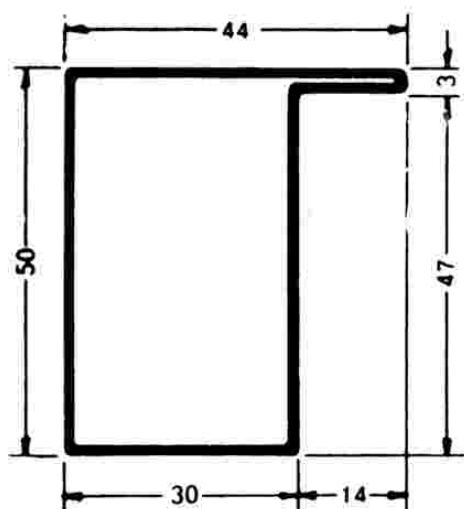

SF 1/B

Spessore 15/10

Peso kg/m. 2,15

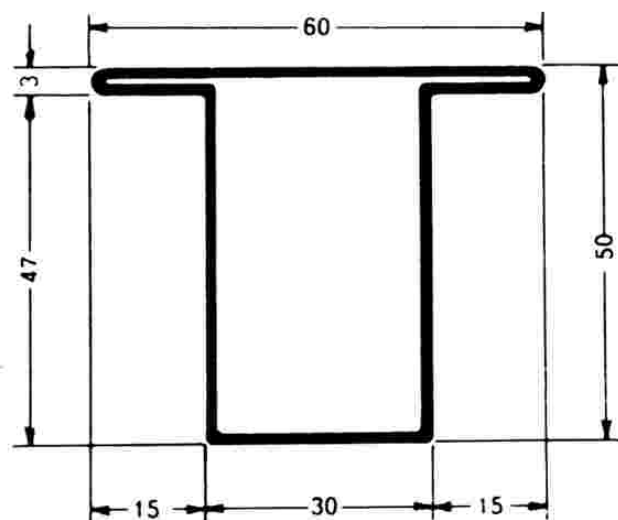

SF 2/B

Spessore 15/10

Peso kg/m. 2,52

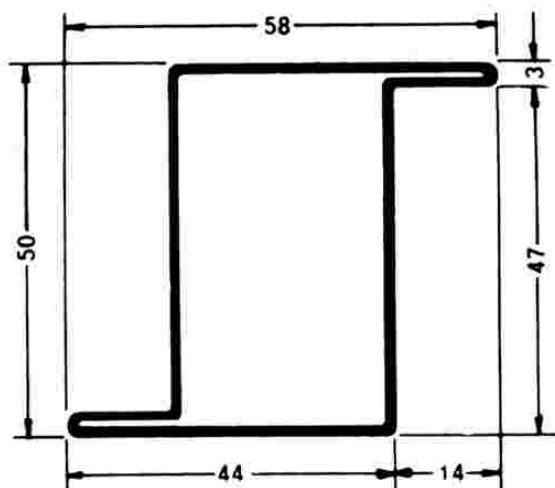

SF 3/B

Spessore 15/10

Peso kg/m. 2,52

16 A

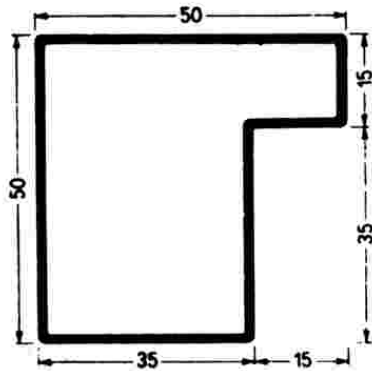

Spessore 15/10 Peso kg/m. 2,30

16 B

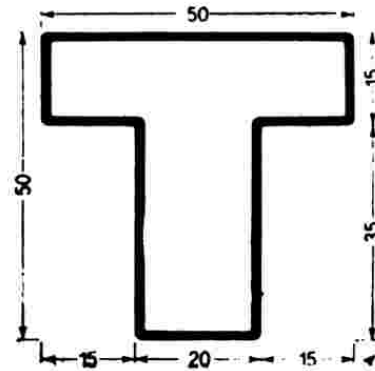

Spessore 15/10 Peso kg/m. 2,30

16 Z

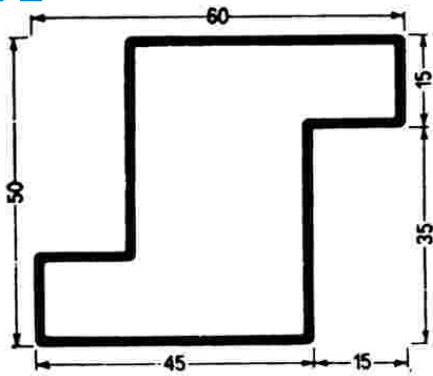

Spessore 15/10 Peso kg/m. 2,55

16 D

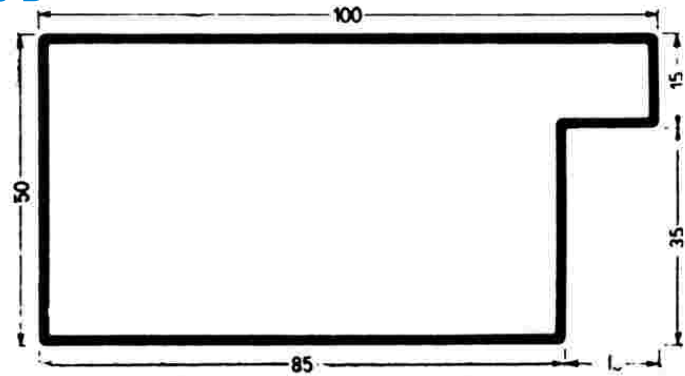

Spessore 20/10 Peso kg/m. 4,65

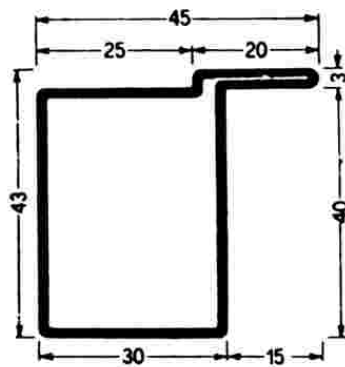

15 A
Spessore 15/10
Peso kg/m. 2,04

15 T

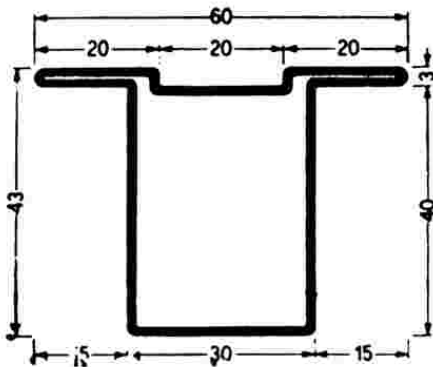

Spessore 15/10 Peso kg/m. 2,45

15 Z

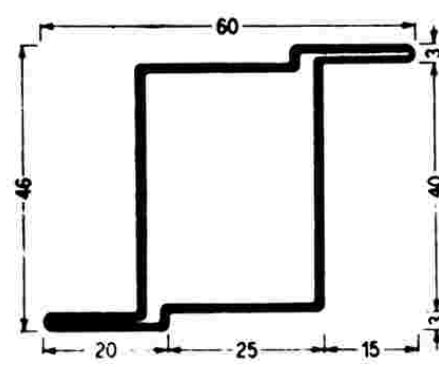

Spessore 15/10 Peso kg/m. 2,45

MT 1

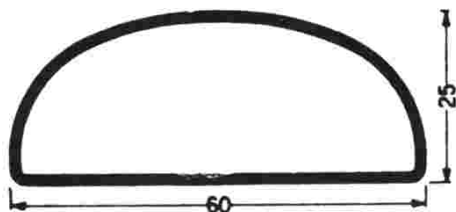

Spessore 15/10

Peso kg/m. 1,72

MT 5

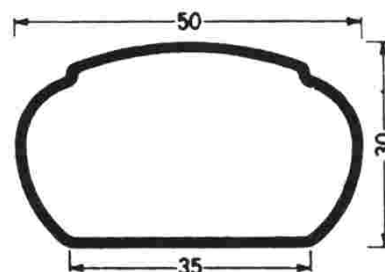

Spessore 15/10

Peso kg/m. 1,65

MT 6

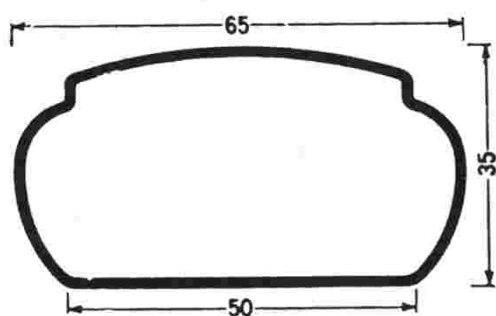

Spessore 15/10

Peso kg/m. 2,15

MT 7

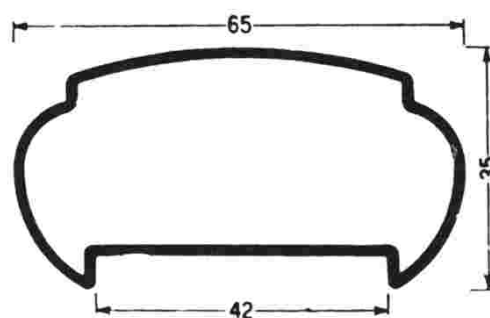

Spessore 15/10

Peso kg/m. 2,15

MT 8

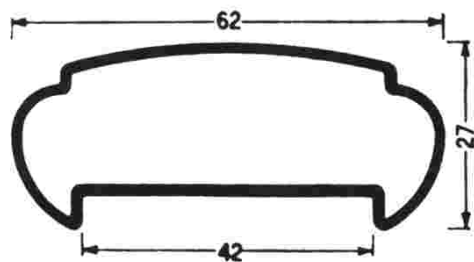

Spessore 15/10

Peso kg/m. 1,87

MT 9

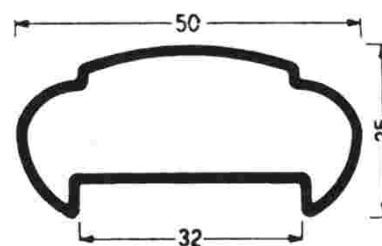

Spessore 15/10

Peso kg/m. 1,60

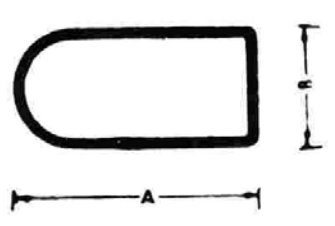
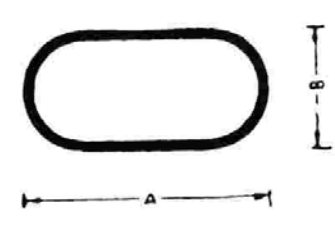
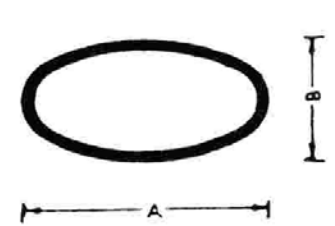
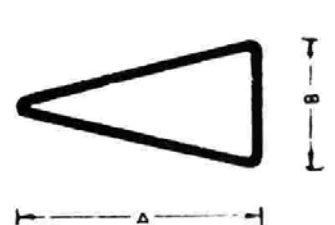
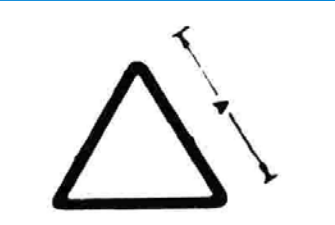
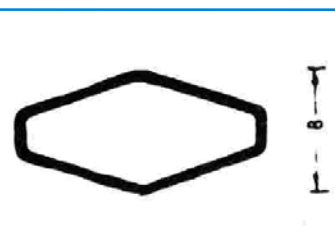
	SEMIOVALE							
	A	30	40	50	60	80	100	
	B	15	20	25	30	40	50	
	KG/M	15/10	1,05	1,35	1,66	1,97	2,67	3,47
		20/10	1,38	1,78	2,17	2,61	3,55	4,54
	OVALE PIATTO							
	A	30	40	50	60	80	100	
	B	15	20	10	30	40	50	
	KG/M	15/10	0,98	1,24	1,2	1,87	2,48	3,00
		20/10	1,28	1,63	1,5	2,47	3,30	3,45
	OVALE ELLITTICO							
	A	30	40	50	60	80		
	B	15	20	25	30	40		
	KG/M	15/10	0,95	1,18	1,18	1,72	2,30	
		20/10	1,23	1,53	1,53	2,27	3,06	
	TRIANGOLO ISOSCELE							
	A	30	40	65	70			
	B	15	22	30	40			
	KG/M	15/10	0,86	1,24	1,79	2,09		
		20/10	1,13	1,63	2,37	2,76		
	TRIANGOLO EQUILATERO							
	A	30	40	50				
	B	30	40	50				
	KG/M	15/10	0,98	1,34	1,69			
		20/10	1,28	1,75	2,22			
	ROMBOIDE							
	A	40	60	80				
	B	20	30	40				
	KG/M	15/10	1,05	1,79	2,30			
		20/10	1,38	2,37	3,06			