

Recupero di solai in acciaio
con voltine in laterizio

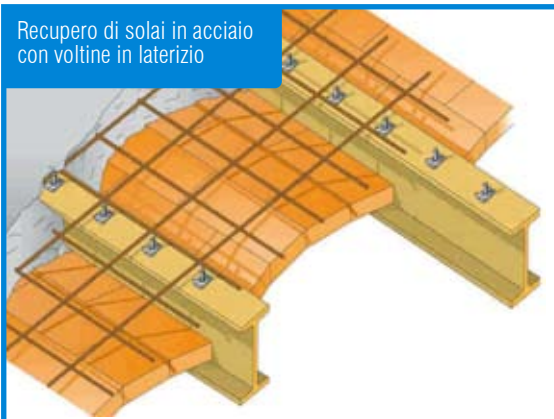

Connettore a piolo

Misure del contenitore

Piastrina di base 35 x 50 mm

Gambo Ø 12 mm

Testata del gambo Ø 18 mm

Altezza 40, 60, 70, 80, 105, e 125 mm

Misure dei chiodi in acciaio

Gambo Ø 4,6 mm

Lunghezza 23 mm

Recupero di solai in acciaio
e laterizio forato

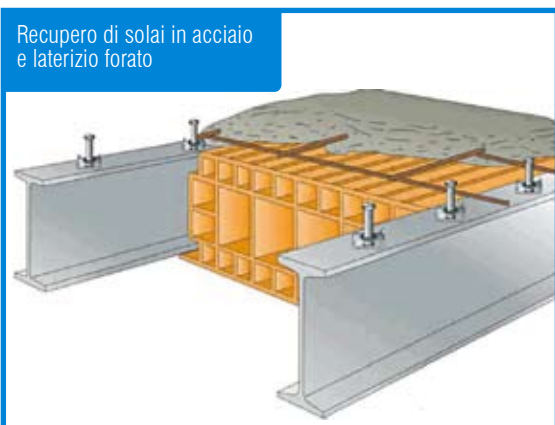

Il connettore a piolo unisce efficacemente acciaio e calcestruzzo, realizzando solai con caratteristiche superiori sia in rigidità che in resistenza. Viene facilmente fissato sulle travi con due chiodi speciali premontati a mezzo di maneggevoli chiodatrici; si evita così l'operazione di saldatura resa spesso difficile dalla presenza di lamiera grecata, da zincatura superficiale o da strati di ruggine e vernice. Ogni connettore può essere fissato in meno di 10 secondi anche da personale non specializzato.

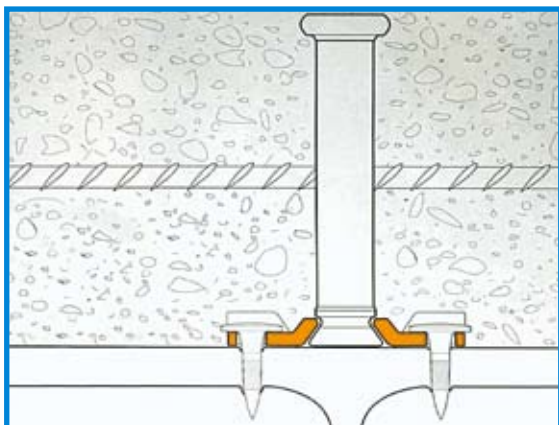

**Il connettore a piolo è stato testato presso
l'Università di Padova, Istituto di Scienza e
Tecnica delle Costruzioni**

Recupero di solai in acciaio
e lamiera grecata



Le apposite chiodatrici per il fissaggio **Pneutek** ed a sparo **Spit** sono molto facili da usare e molto sicure. È possibile noleggiarle.

Materiali	Finitura	Dimensioni				Confezioni
		A	B	C	D	
Acciaio	Zincato	46	15	33	36	500
Acciaio	Preverniciato	46	15	33	36	500
Acciaio	Inox	46	15	33	36	500
Alluminio	Alluminio	46	15	33	36	500
Rame	Rame	46	15	33	36	500

Cappellotti per lamiera grecate



Colmi grecati per coperture

Materiali	Finitura	Dimensioni
Acciaio	Zincato	Su richiesta
Acciaio	Preverniciato	
Acciaio	Inox	
Alluminio	Alluminio	
Rame	Rame	

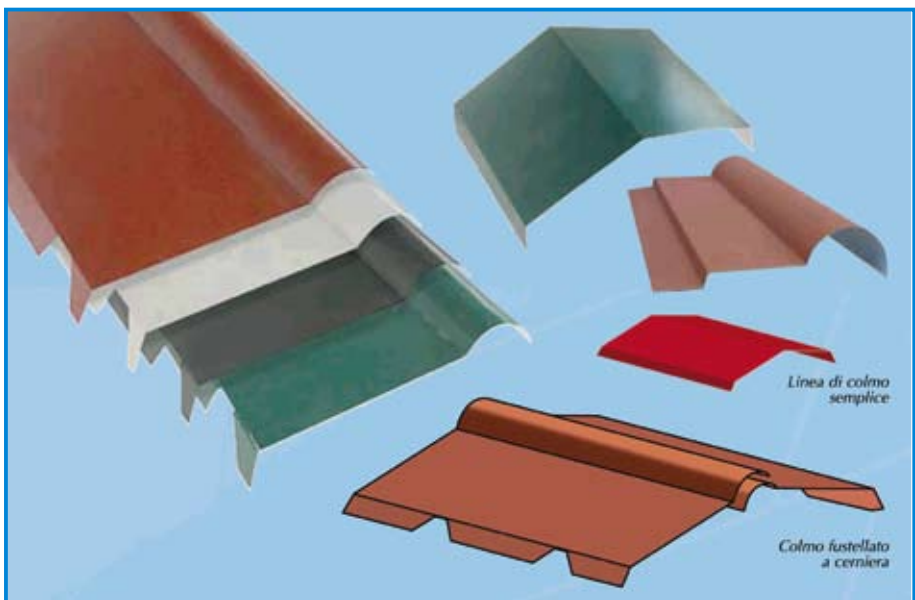
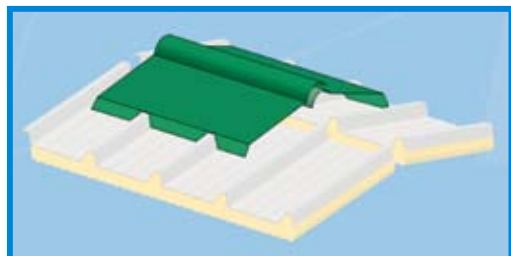

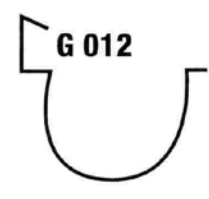
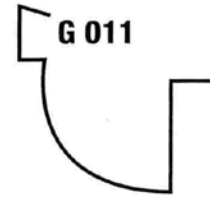
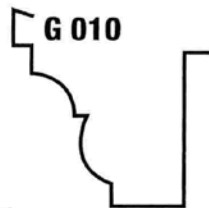
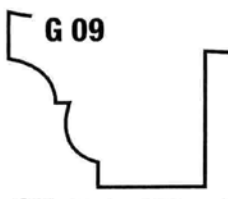
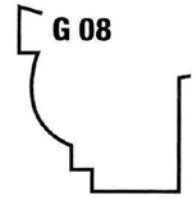
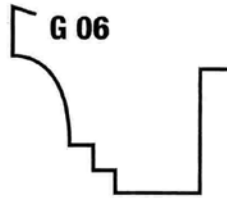
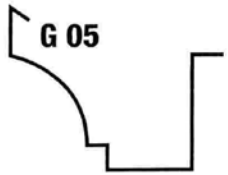
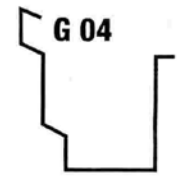
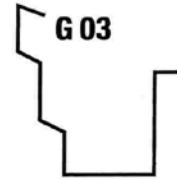
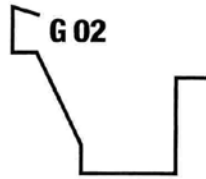
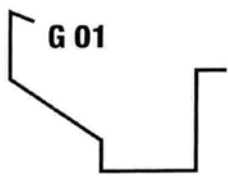

SV 25 - 33 - 40 - 50 - 60



Mod. 28
Mod. 33



Mod. 28 SV 33
Mod. 33 SV 40

Scossaline e Gronde

